

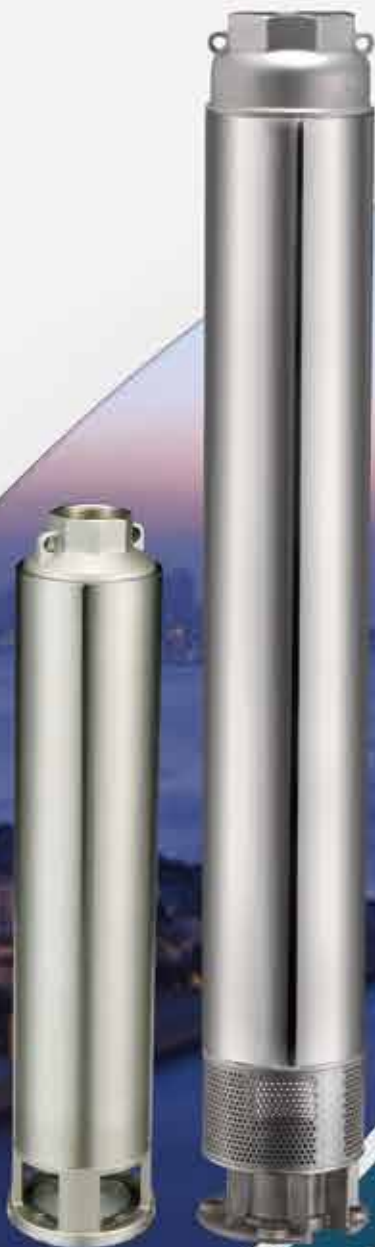

ST 4", 6" Series 50Hz

Submersible Electric Pumps



STAIRS INDUSTRIAL CO., LTD.

ST 4" ,6"
General Data

Performance Range	1
Model Code	2
Applications	2
Description	2
General Specifications Pump	2
Materials	3

ST 4" Technical Data

ST 05	4
ST 07	6
ST 10	8
ST 13	10
ST 18	12
ST 25	14
ST 35	16
ST 40	18
ST 40E	20
ST 55	22
ST 60	24
ST 60E	26
ST 80	28
ST 80E	30

ST 6" Technical Data

ST 50	32
ST 75	34
ST 135	36
ST 180	38
ST 220	40

4"&6" ST Submersible Electric Pumps

STAIRS ST Series is a robust 4" pump designed for long life and sand handling. It is built mainly in stainless steel, a casted discharge, a casted bracket and a special floating impeller. The design is to enhance the wear resistance and to maintain the performance over time.

Wide range of application of irrigation systems, pressure boosting, water supply and fountain applications for 4" well. All ST pumps can be coupled to 4" NEMA standard motors.

Stairs 6" ST submersible pumps for high pressures and flow rates, particularly equipped with a high rigidity Silicon-Carbide(SiC) Bearing, provide reliability and quality guaranteed.

Performance Range

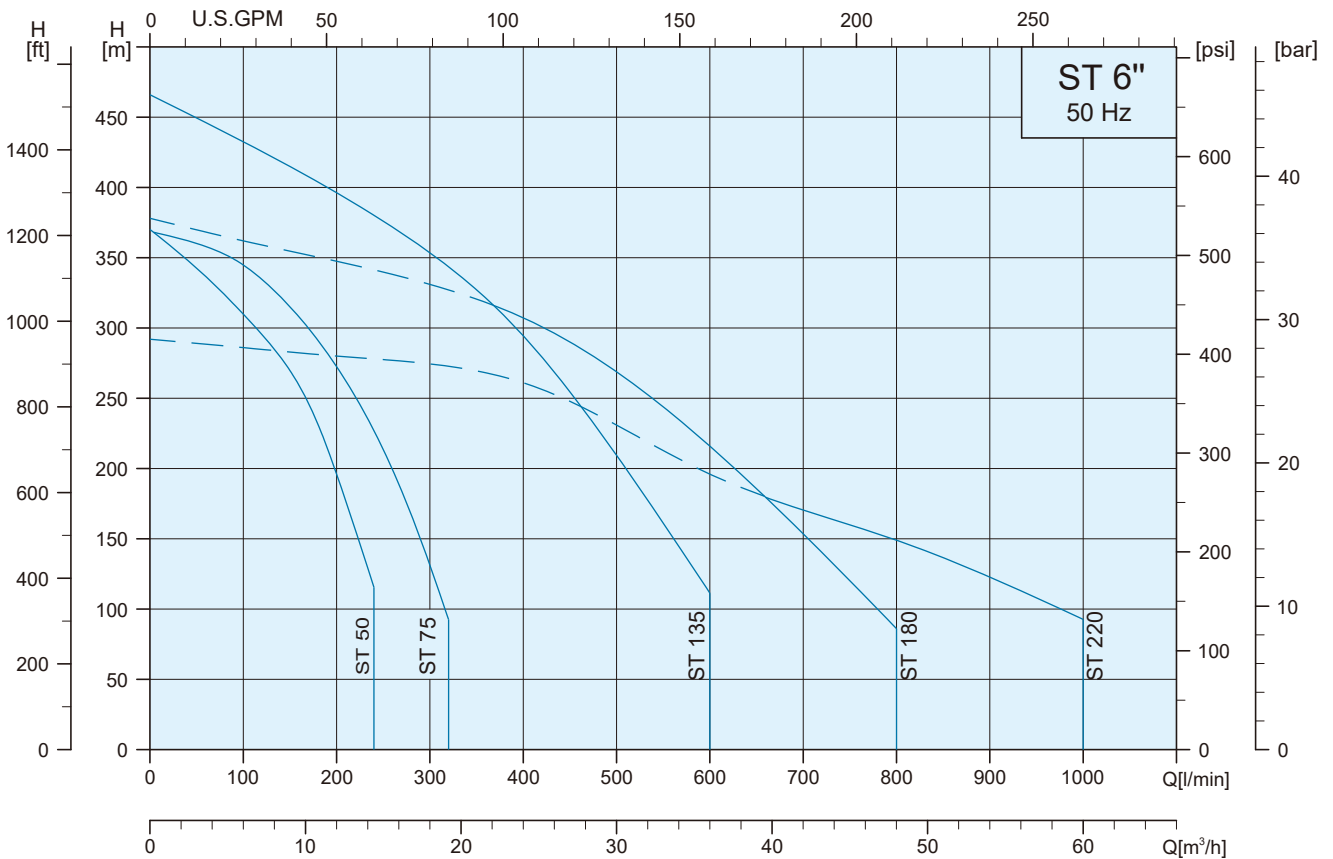
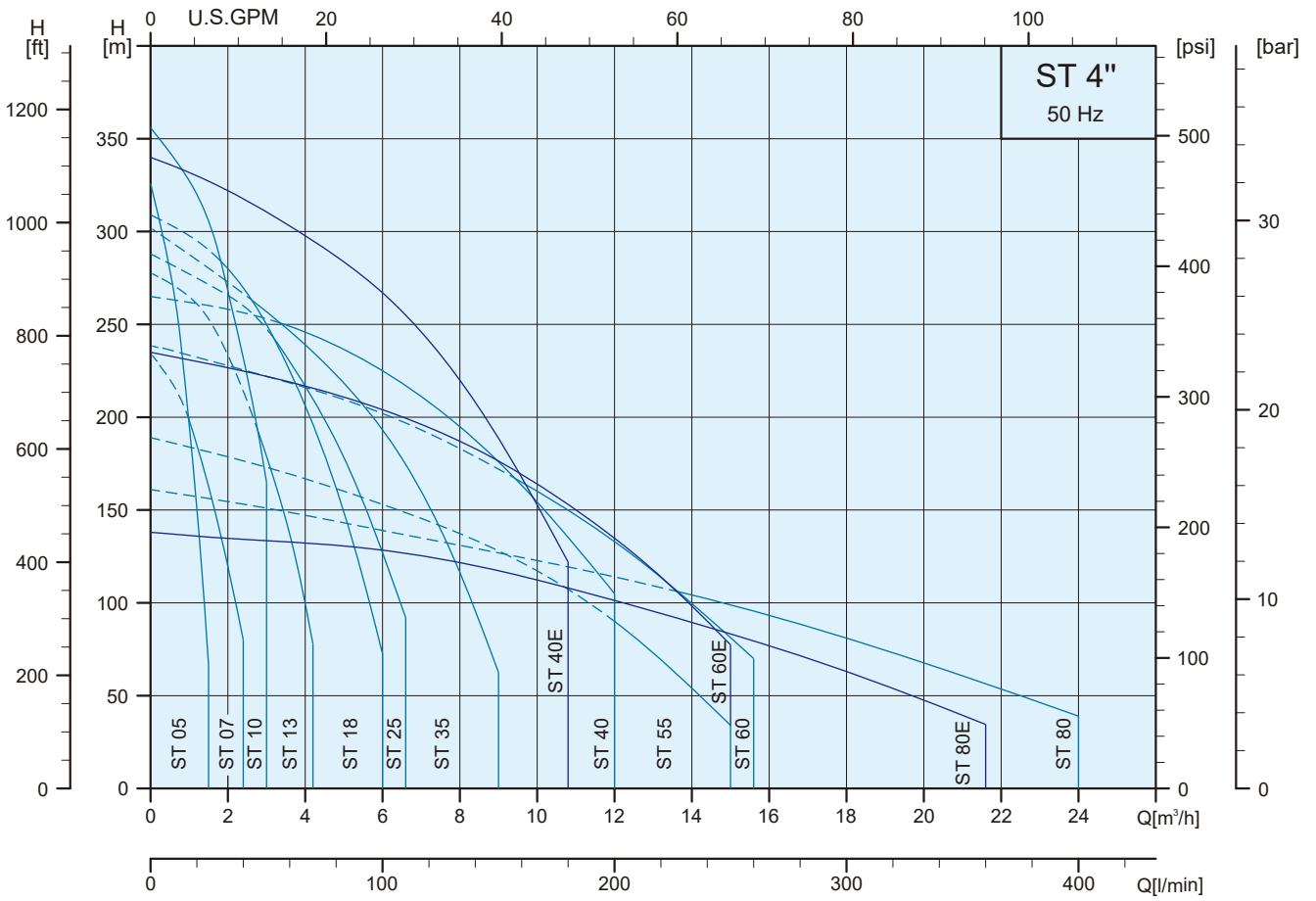



Model Code

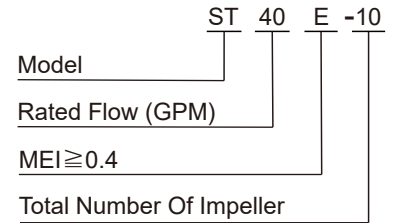
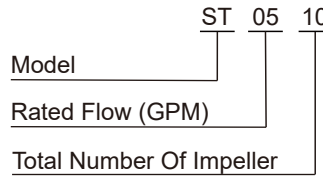

Applications

- Water Supply
- Irrigation
- Pressure Boosting

General Specifications Pump

ST 4"	ST 6"
Delivery : up to 24 m ³ /h at 2850 rpm	Delivery : up to 60 m ³ /h at 2850 rpm
Head : up to 356 m at 2850 rpm	Head: up to 466 m at 2850 rpm
Maximum permissible quantity of sand : 200g/m ³	Maximum permissible quantity of sand : 100g/m ³
ST05-ST07-ST10-ST13-ST18 models 1 1/4" discharge.	ST 50-ST75-ST135-ST180-ST220 models 3" discharge.
ST25 model 1 1/2" discharge.	Max. Liquids temperature : 60°C
ST35-ST40-ST55-ST60-ST80 models 2" discharge	
Max. Liquids temperature : 60°C	

ST 4"

Bearing is made with Polyacetal for strong wear and abrasive resistance.

ST 4",6"

Discharge Head and Motor Adaptor are precision machined cast 304 stainless steel for superior strength and durability.

The motor adaptor is NEMA standard.

Impeller Bowls are made from 304 stainless steel, maximizing wear from abrasion.

Strainer is made from stamped 304 stainless steel for rigidity.

Pump Shaft is made from hex 304 stainless steel bar material for high corrosion resistance.

Pump body is covered by a 4"1.5mm/6"2.0mm thick 304 polished stainless steel casing, ensures optimum resistance to abrasion.

Impellers are floating type made with Noryl® for a superior sand handling.

Together with glass filled polycarbonate diffusers make the super strong pumps for maximum wear and abrasive resistance.

The materials are FDA compliant materials.

Shaft Coupling is made from 304 stainless steel for easy alignment to the motor shaft.

Non-Return valve made from 304 stainless steel, fitted in the discharge to prevent any back flow of water and alleviate any water hammer to the pumps.

Materials

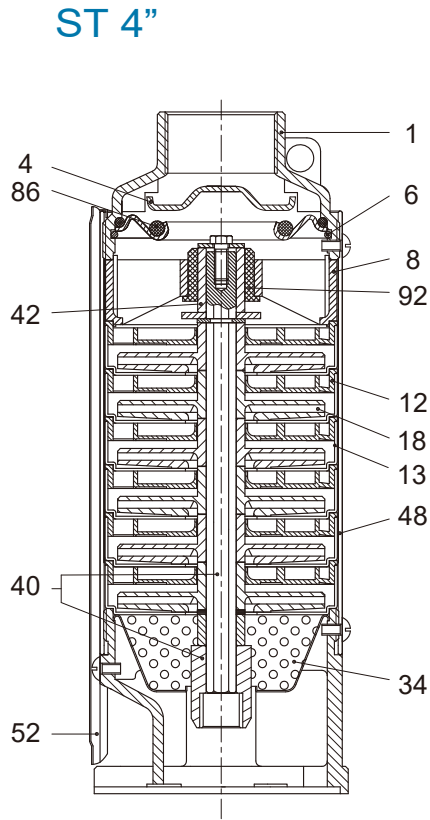

Pos.	Part Name	Materials
1	Discharge Head	AISI 304 SS
4	Check Valve Cone	AISI 304 SS
6	Check Valve retaining Ring	AISI 304 SS
8	Bearing Spider	Glass Filled Polycarbonate
12	Diffuser	Glass Filled Polycarbonate
13	Bowl	AISI 304 SS
18	Impeller	Noryl
34	Strainer	AISI 304 SS
40	Pump Shaft / Coupling	AISI 304 SS
42	Shaft Sleeve	AISI 304 SS or Noryl
48	Pump Casing	AISI 304 SS
52	Cable Guard	AISI 304 SS
86	O-Ring	NBR
92	Bearing	Polyacetal

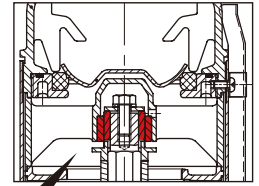
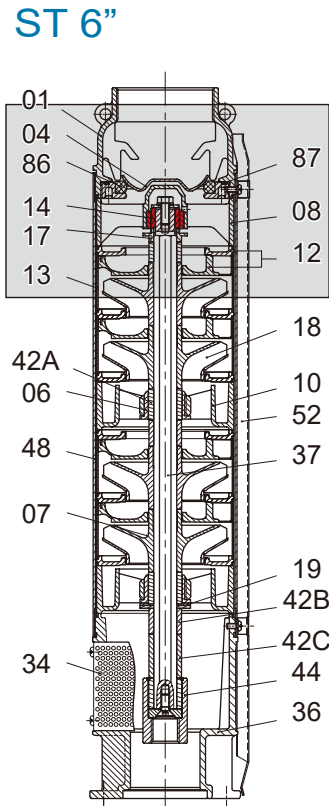

High rigidity
Silicon-Carbide(SiC) Bearing
 ensure high corrosion resistance
 and provide long and dependable
 service life.

Pos.	Part Name	Material
1	Discharge	AISI 304
4	Valve cone	AISI 304
6	Bearing	POM+PTFE
7	Bearing	Bronze
8	Upper bearing spider	AISI 304+ Silicon carbide
10	Bearing Spider	Noryl
12	Diffuser	Glass Filled Polycarbonate
13	Diffuser casing	AISI 304
14	Bearing ring	Silicon carbide
17	Sleeve for baffle	AISI 304
18	Impeller	Noryl
19	Counter thrust bearing plate	Carbon fiber + PTFE
34	Strainer	AISI 304
36	Suction interconnector	AISI 304
37	Pump shaft	AISI 304
42A	Shaft sleeve	AISI 304
42B	Shaft sleeve	Noryl
42C	Shaft sleeve	Noryl
44	Coupling	AISI 304
48	Pump casing	AISI 304
52	Cable guard	AISI 304
86	Valve Seat	AISI 304 + NBR
87	O-ring	NBR

ST 50Hz

General Data



Performance Curves

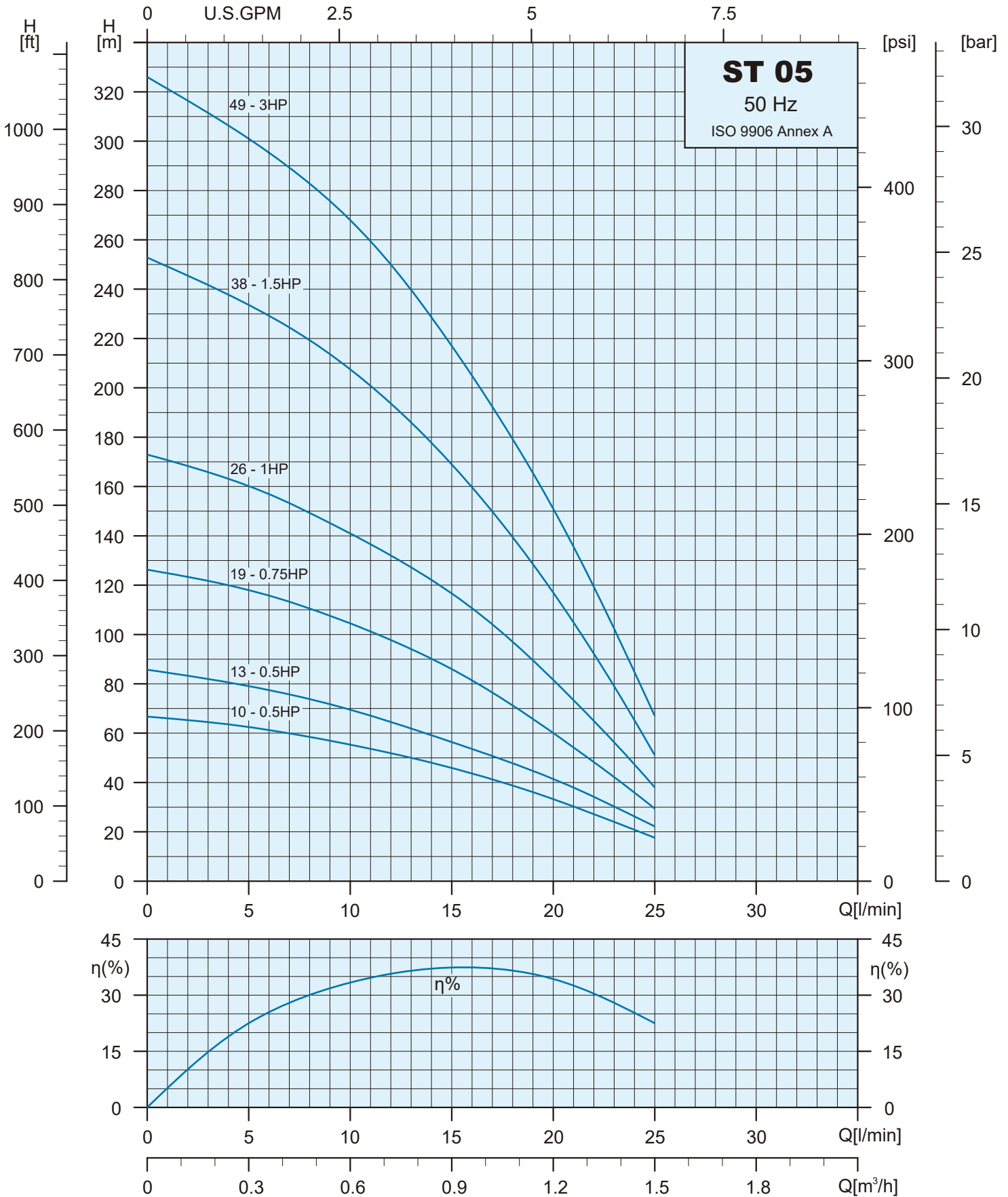

Specifications

Pump Type	Motor		Q=DELIVERY						
	kW	HP	l/min	0	5	10	15	20	25
			m ³ /h	0	0.3	0.6	0.9	1.2	1.5
ST 05-10	0.37	0.5	H (m)	67	63	55	46	33	18
ST 05-13	0.37	0.5		86	78	70	56	42	23
ST 05-19	0.55	0.75		126	118	105	86	60	30
ST 05-26	0.75	1.0		173	160	141	117	81	39
ST 05-38	1.1	1.5		253	234	208	169	117	52
ST 05-49	2.2	3.0		326	301	268	219	151	67

Dimensions and Weights

Pump Type	Dimensions (mm)			Net Weight (kg)
	A	B	C	PUMP
ST 05-10	324	Rp 1 1/4" NPT 1 1/4"	98	3.3
ST 05-13	377		98	3.7
ST 05-19	481		98	4.7
ST 05-26	642		98	5.8
ST 05-38	910		98	9.2
ST 05-49	1105		98	12.5

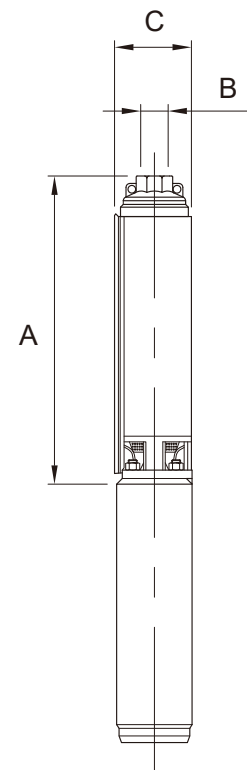

Performance Curves

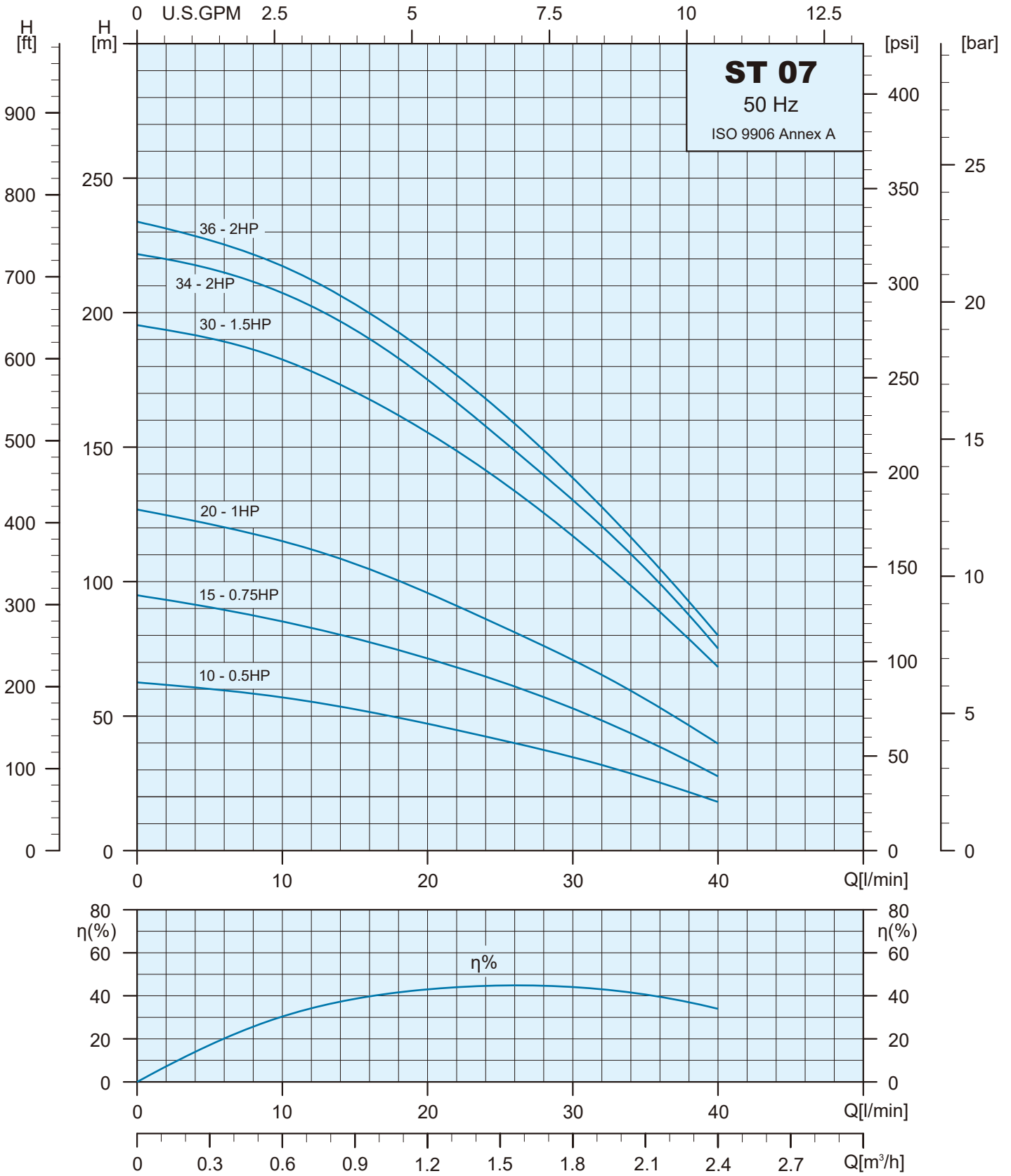

Specifications

Pump Type	Motor		Q=DELIVERY								
	kW	HP	l/min	0	10	15	20	25	30	35	40
			m ³ /h	0	0.6	0.9	1.2	1.5	1.8	2.1	2.4
ST 07-10	0.37	0.5	H (m)	63	57	53	47	42	35	27	18
ST 07-15	0.55	0.75		95	86	78	72	63	53	41	28
ST 07-20	0.75	1.0		127	115	107	96	84	71	56	40
ST 07-30	1.1	1.5		195	183	171	156	138	117	94	69
ST 07-34	1.5	2.0		222	207	194	175	154	130	104	76
ST 07-36	1.5	2.0		234	217	203	185	164	138	110	80

Dimensions and Weights

Pump Type	Dimensions (mm)			Net Weight (kg)
	A	B	C	PUMP
ST 07-10	330	Rp 1 1/4" NPT 1 1/4"	98	3.3
ST 07-15	420		98	4.3
ST 07-20	510		98	5.3
ST 07-30	730		98	7.4
ST 07-34	858		98	9.3
ST 07-36	895		98	9.8

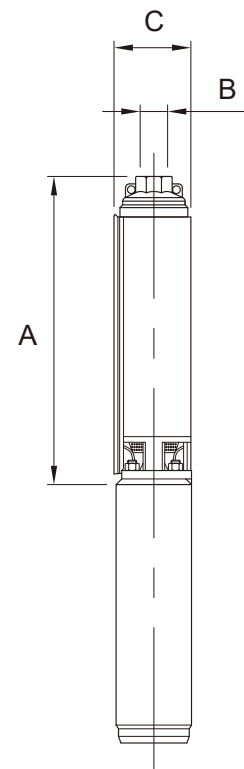

Performance Curves

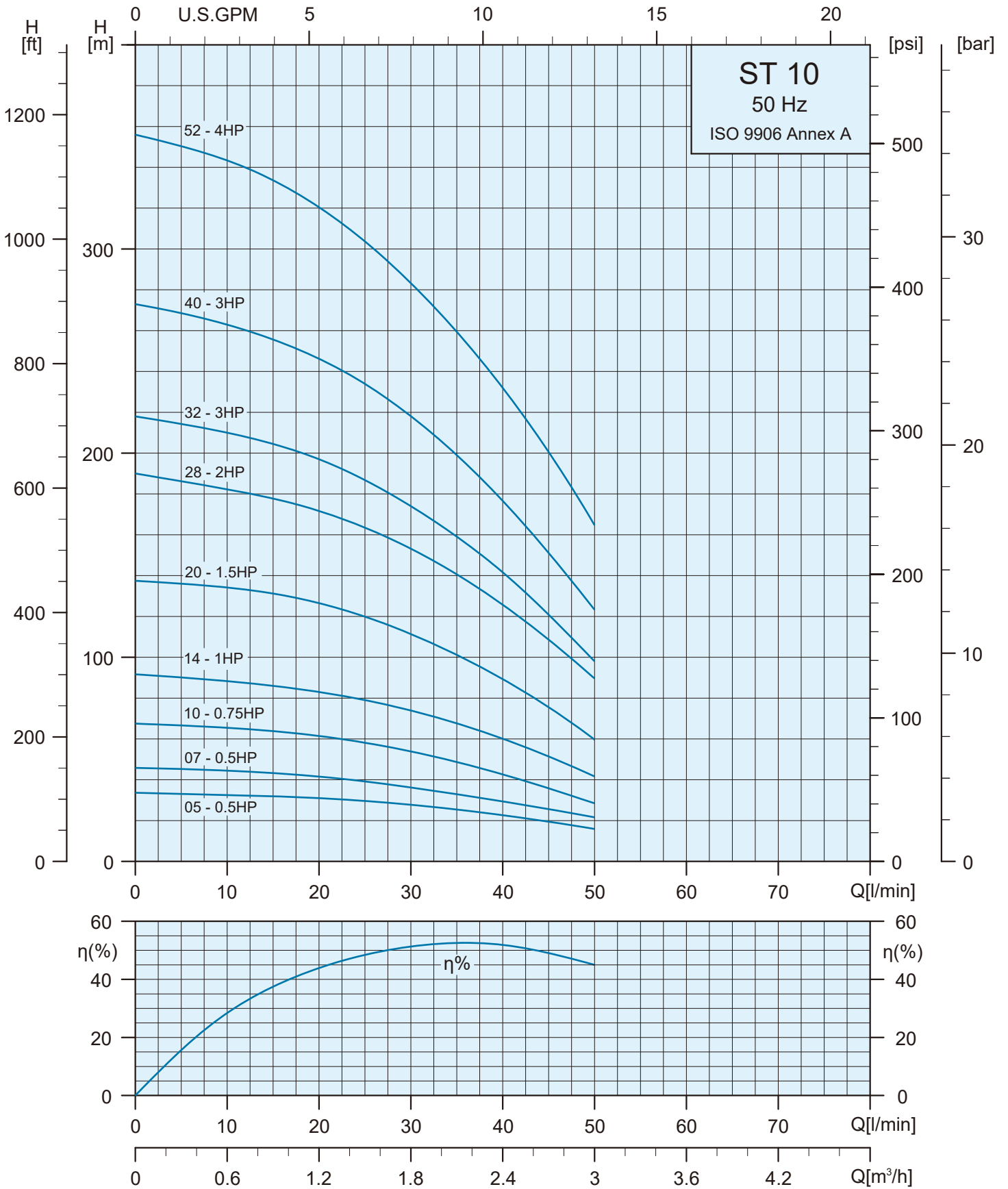

Specifications

Pump Type	Motor		Q=DELIVERY									
	kW	HP	l/min	0	15	20	25	30	35	40	45	50
			m ³ /h	0	0.9	1.2	1.5	1.8	2.1	2.4	2.7	3.0
ST 10-05	0.37	0.5	H (m)	34	32	31	29	27	25	23	19	16
ST 10-07	0.37	0.5		46	43	42	39	36	33	29	26	22
ST 10-10	0.55	0.75		67	64	61	58	54	49	43	36	28
ST 10-14	0.75	1.0		92	86	83	79	74	67	60	52	42
ST 10-20	1.1	1.5		139	131	127	120	111	101	90	75	60
ST 10-28	1.5	2.0		190	178	172	163	153	141	126	108	89
ST 10-32	2.2	3.0		218	205	197	187	174	159	142	121	98
ST 10-40	2.2	3.0		273	256	246	234	218	199	177	151	123
ST 10-52	3.0	4.0		356	334	320	304	283	259	232	201	165

Dimensions and Weights

Pump Type	Dimensions (mm)			Net Weight (kg)
	A	B	C	PUMP
ST 10-05	236	Rp 1 1/4" NPT 1 1/4"	98	2.5
ST 10-07	271		98	2.8
ST 10-10	324		98	3.3
ST 10-14	394		98	3.9
ST 10-20	499		98	4.9
ST 10-28	679		98	7.1
ST 10-32	787		98	7.8
ST 10-40	950		98	10.5
ST 10-52	1235		98	13.5

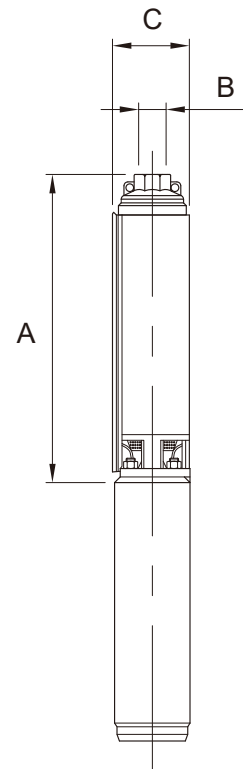

Performance Curves

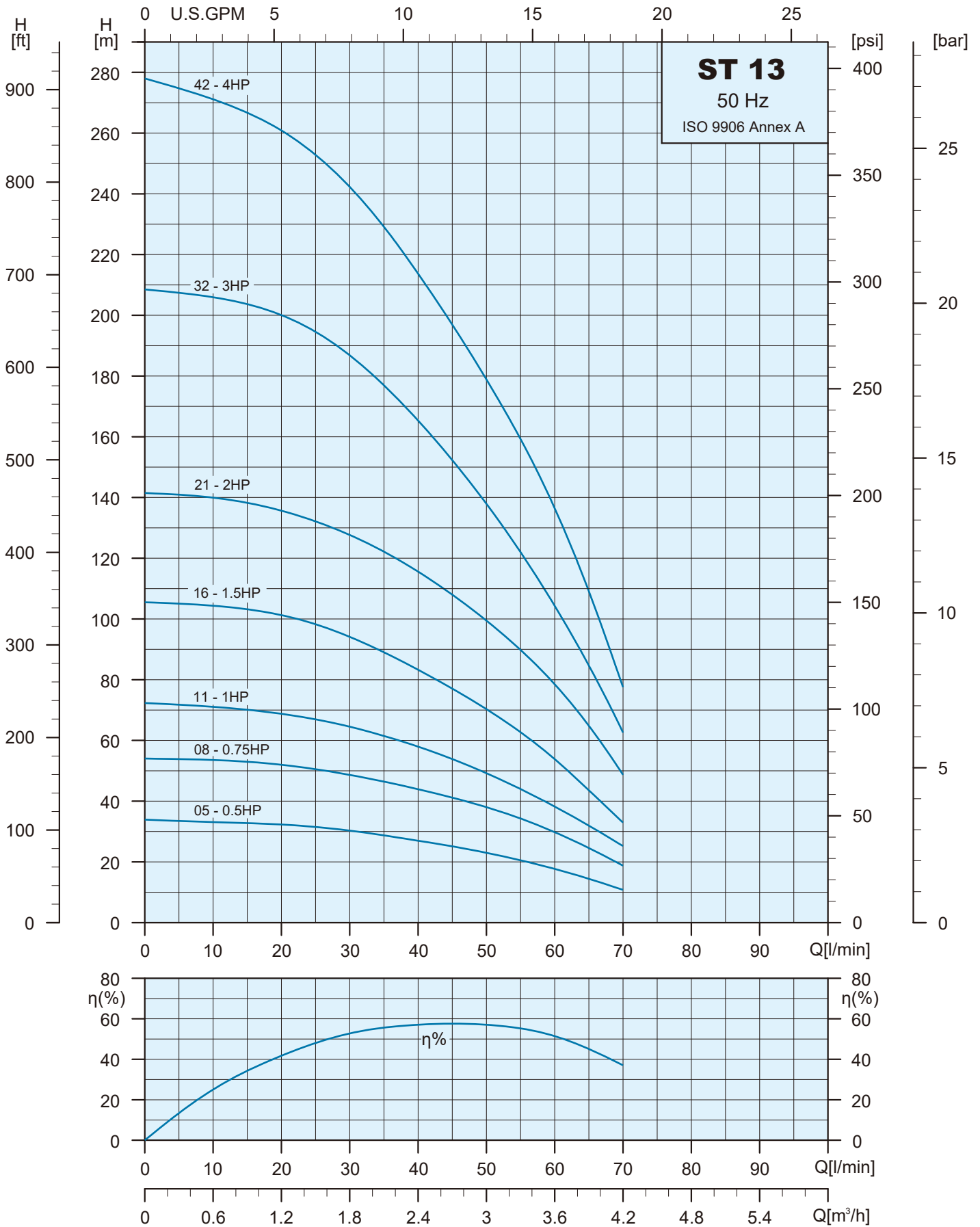

Specifications

Pump Type	Motor		Q=DELIVERY										
	kW	HP	l/min	0	20	25	30	35	40	45	50	60	70
			m ³ /h	0	1.2	1.5	1.8	2.1	2.4	2.7	3.0	3.6	4.2
ST 13-05	0.37	0.5	H (m)	34	32	31	30	29	27	25	23	18	11
ST 13-08	0.55	0.75		54	51	50	49	46	43	41	38	30	19
ST 13-11	0.75	1.0		72	68	66	64	61	58	54	49	38	26
ST 13-16	1.1	1.5		106	101	98	95	89	83	77	70	54	33
ST 13-21	1.5	2.0		142	135	132	127	122	115	108	100	79	49
ST 13-32	2.2	3.0		208	200	194	187	177	165	152	138	104	62
ST 13-42	3.0	4.0		278	261	253	242	229	214	197	179	137	78

Dimensions and Weights

Pump Type	Dimensions (mm)			Net Weight (kg)
	A	B	C	PUMP
ST 13-05	236	Rp 1 1/4" NPT 1 1/4"	98	2.5
ST 13-08	289		98	2.9
ST 13-11	342		98	3.4
ST 13-16	430		98	4.2
ST 13-21	519		98	5.0
ST 13-32	805		98	8.1
ST 13-42	985		98	10.7

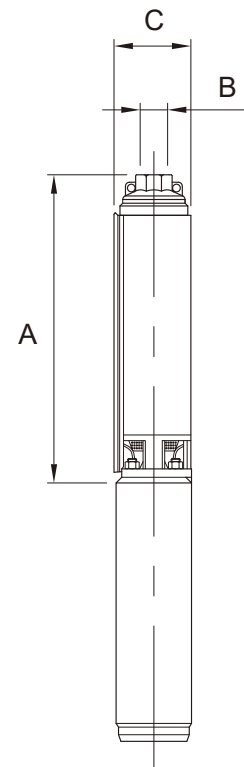

Performance Curves

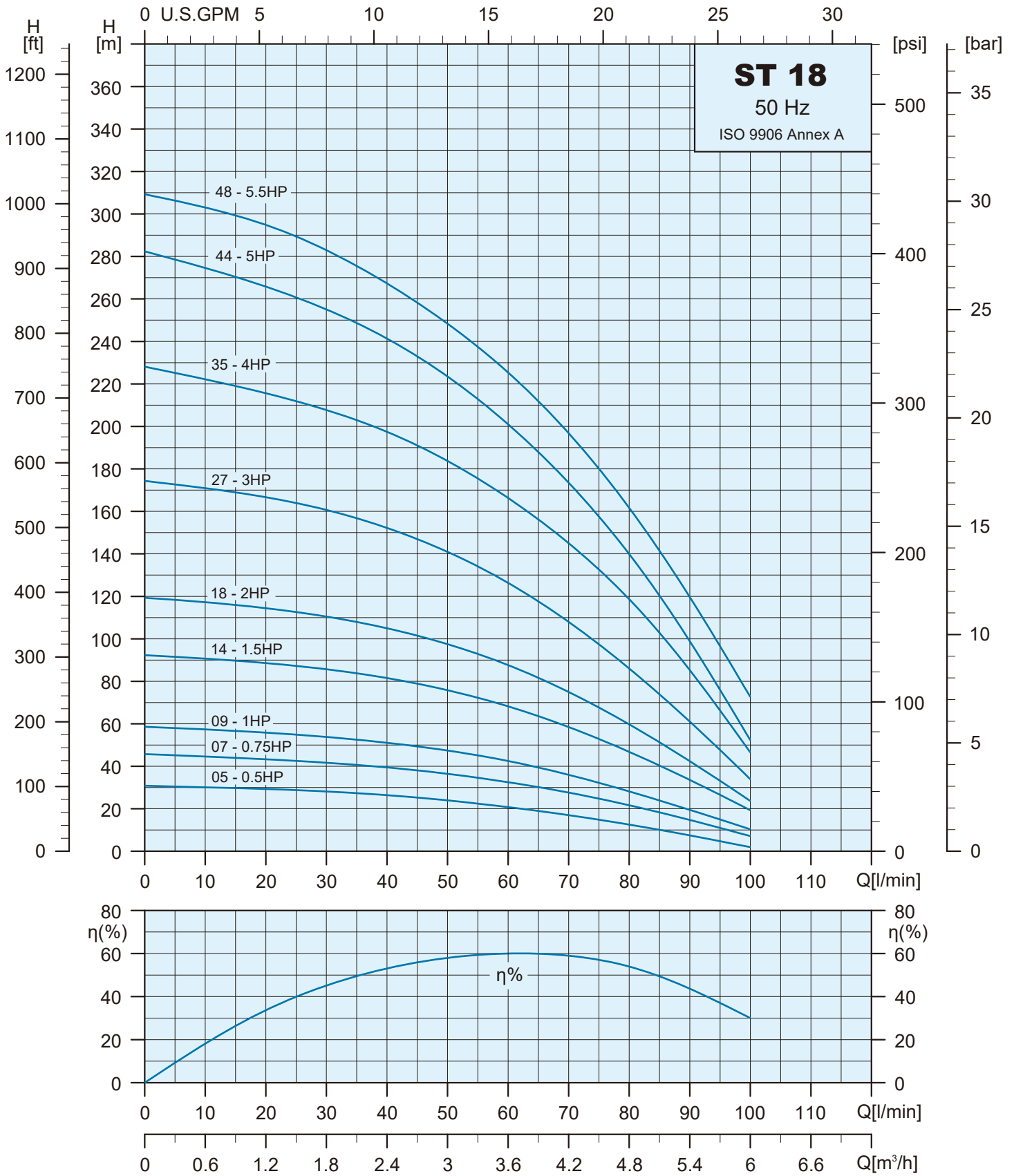

Specifications

Pump Type	Motor		Q=DELIVERY												
	kW	HP	l/min	0	25	30	35	40	45	50	60	70	80	90	100
			m ³ /h	0	1.5	1.8	2.1	2.4	2.7	3.0	3.6	4.2	4.8	5.4	6.0
ST 18-05	0.37	0.5	H (m)	33	29	28	27	26	25	24	21	18	13	8	3
ST 18-07	0.55	0.75		46	43	42	41	39	38	36	33	28	22	15	7
ST 18-09	0.75	1.0		59	55	54	52	51	49	47	43	37	28	20	10
ST 18-14	1.1	1.5		93	87	86	83	81	79	76	68	58	47	33	20
ST 18-18	1.5	2.0		120	113	111	108	105	102	98	88	75	60	42	25
ST 18-27	2.2	3.0		175	164	161	157	152	147	141	127	109	87	61	35
ST 18-35	3.0	4.0		228	212	208	203	197	191	184	166	145	119	85	46
ST 18-44	3.7	5.0		282	261	255	249	241	233	223	201	173	140	99	52
ST 18-48	4.0	5.5		309	289	283	276	267	258	248	225	197	162	120	73

Dimensions and Weights

Pump Type	Dimensions (mm)			Net Weight (kg)
	A	B	C	PUMP
ST 18-05	257	Rp 1 1/4" NPT 1 1/4"	98	2.7
ST 18-07	301		98	3.0
ST 18-09	344		98	3.3
ST 18-14	452		98	4.1
ST 18-18	538		98	4.7
ST 18-27	805		98	7.2
ST 18-35	995		98	8.9
ST 18-44	1187		98	10.3
ST 18-48	1312		98	10.9

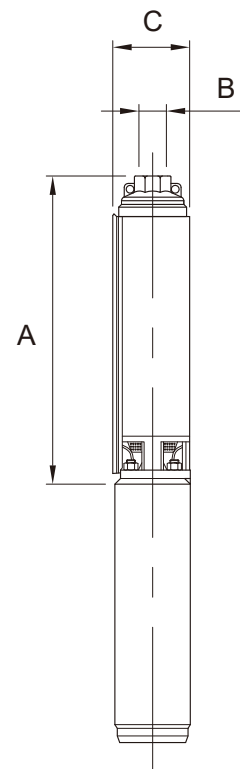

Performance Curves

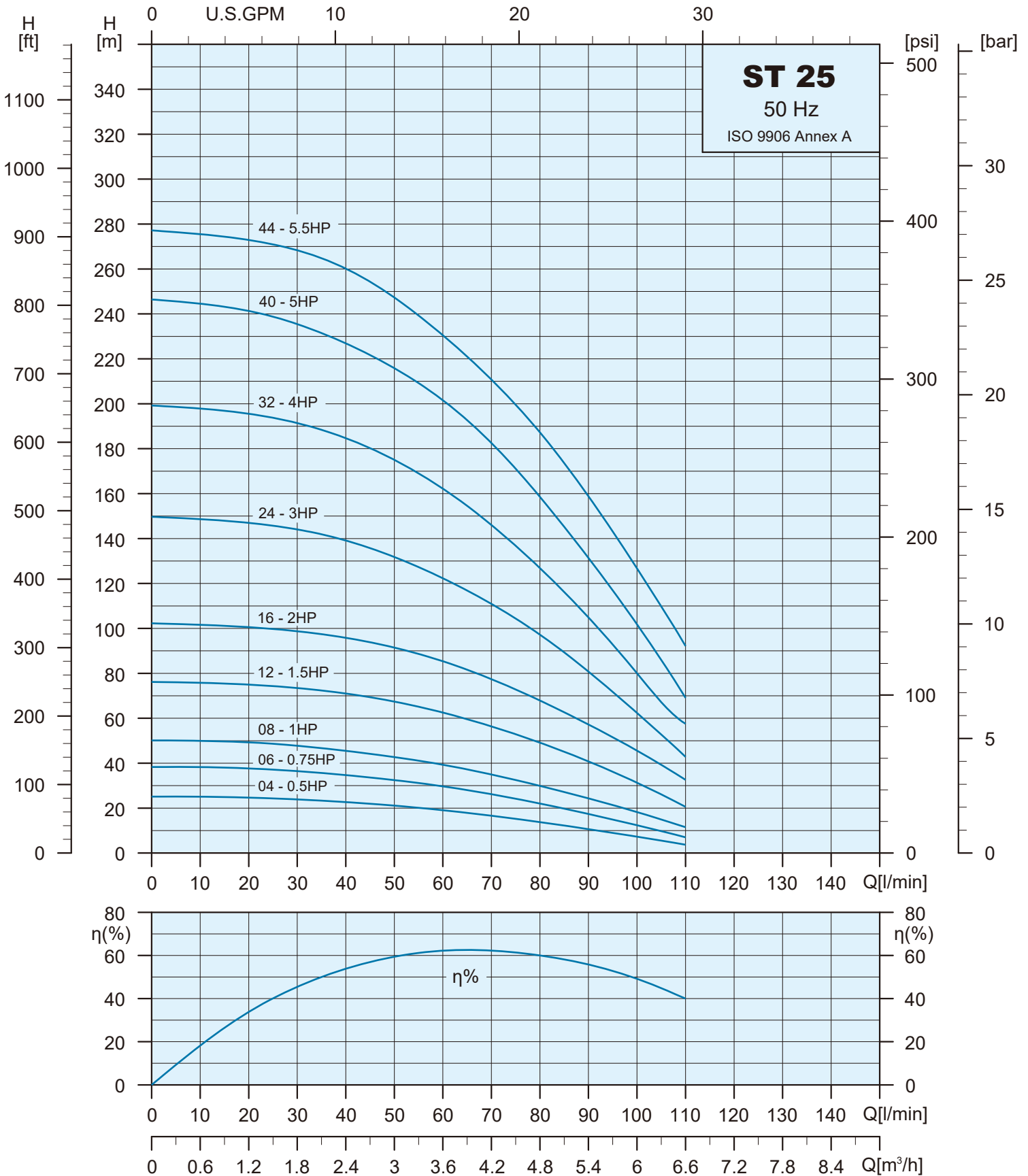

Specifications

Pump Type	Motor		Q=DELIVERY										
	kW	HP	l/min	0	35	40	45	50	60	70	80	90	100
			m ³ /h	0	2.1	2.4	2.7	3.0	3.6	4.2	4.8	5.4	6.0
ST 25-04	0.37	0.5	H (m)	26	23	22	22	21	19	17	14	11	7
ST 25-06	0.55	0.75		38	36	35	33	32	30	26	22	18	12
ST 25-08	0.75	1.0		51	47	46	44	43	39	35	30	24	18
ST 25-12	1.1	1.5		77	72	71	69	68	63	57	49	41	31
ST 25-16	1.5	2.0		102	98	96	94	92	86	77	68	57	46
ST 25-24	2.2	3.0		151	142	139	136	132	122	111	97	80	62
ST 25-32	3.0	4.0		203	188	185	180	175	162	146	127	105	80
ST 25-40	3.7	5.0		253	232	227	222	216	202	182	159	131	102
ST 25-44	4.0	5.5		278	265	260	254	247	230	210	187	159	127

Dimensions and Weights

Pump Type	Dimensions (mm)			Net Weight (kg)
	A	B	C	PUMP
ST 25-04	247	Rp 1 1/2" NPT 1 1/2"	98	2.4
ST 25-06	296		98	2.9
ST 25-08	345		98	3.3
ST 25-12	445		98	4.1
ST 25-16	542		98	5.0
ST 25-24	815		98	7.6
ST 25-32	1028		98	9.7
ST 25-40	1220		98	11.4
ST 25-44	1359		98	12.2

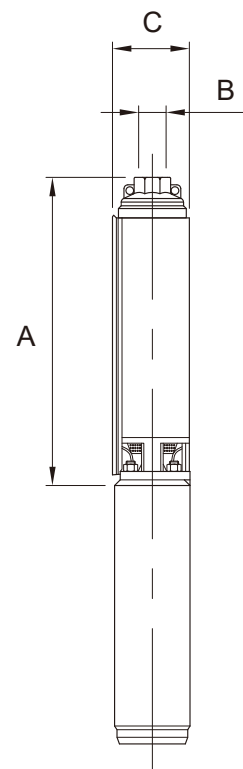

Performance Curves

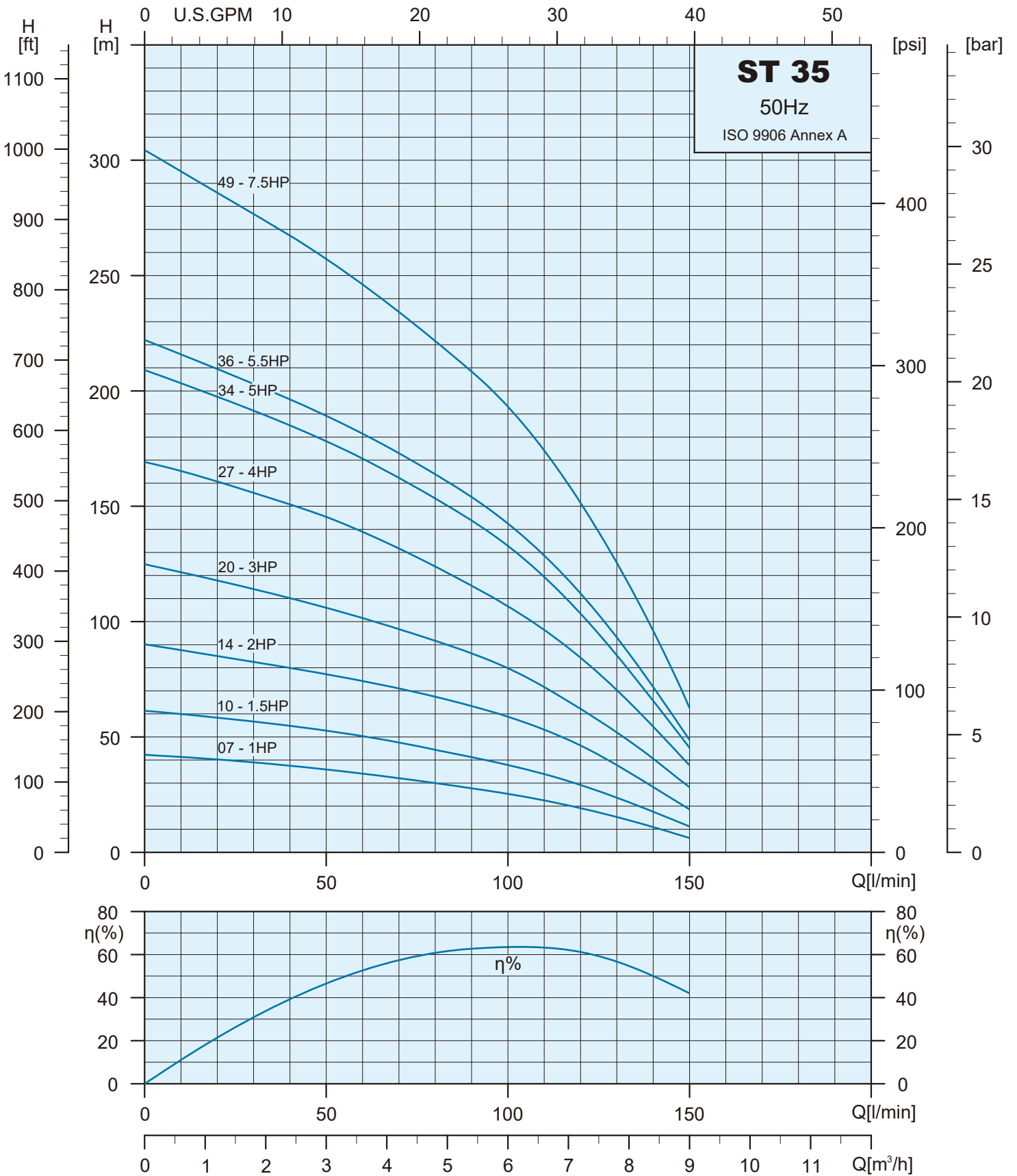

Specifications

Pump Type	Motor		Q=DELIVERY									
	kW	HP	l/min	0	50	60	70	80	90	100	120	140
			m ³ /h	0	3.0	3.6	4.2	4.8	5.4	6.0	7.2	8.4
ST 35-07	0.75	1.0	H (m)	42	36	34	32	30	28	25	19	11
ST 35-10	1.1	1.5		62	53	51	48	45	41	38	29	18
ST 35-14	1.5	2.0		90	77	74	71	68	63	59	46	28
ST 35-20	2.2	3.0		125	107	102	97	92	86	80	62	40
ST 35-27	3.0	4.0		169	145	139	131	123	115	107	84	55
ST 35-34	3.7	5.0		208	178	170	162	153	143	132	103	66
ST 35-36	4.0	5.5		221	190	181	173	164	154	143	112	72
ST 35-49	5.5	7.5		302	257	246	234	222	209	193	151	96

Dimensions and Weights

Pump Type	Dimensions (mm)			Net Weight (kg)
	A	B	C	PUMP
ST 35-07	390	Rp 2" NPT 2"	98	3.7
ST 35-10	483		98	4.6
ST 35-14	607		98	5.7
ST 35-20	831		98	7.5
ST 35-27	1086		99	10.6
ST 35-34	1325		98	12.6
ST 35-36	1384		98	13.2
ST 35-49	1863		98	16.9

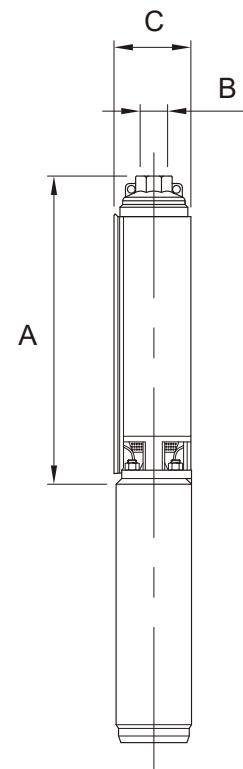

Performance Curves

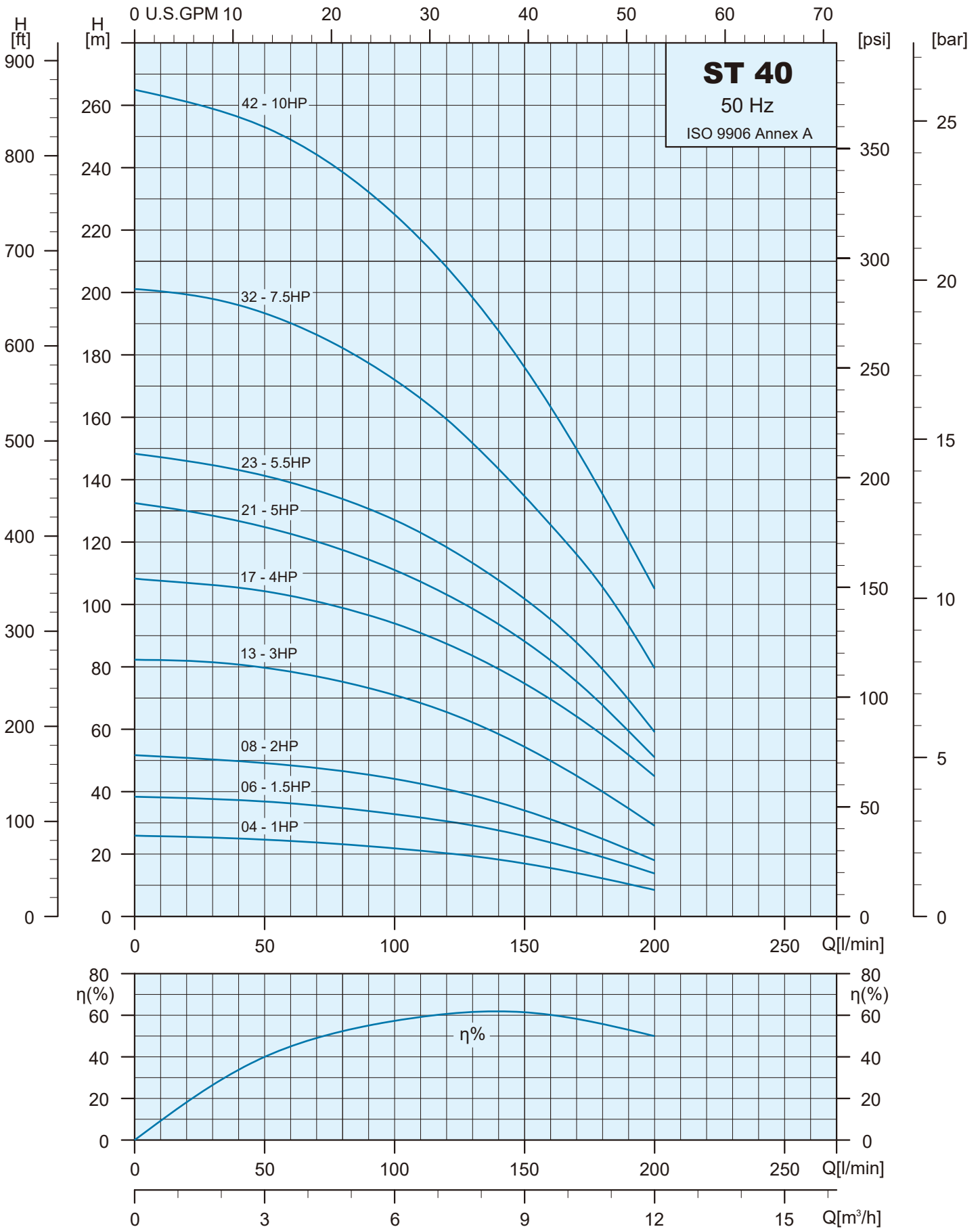

Specifications

Pump Type	Motor		Q=DELIVERY									
	kW	HP	l/min	0	80	90	100	120	140	160	180	200
			m ³ /h	0	4.8	5.4	6.0	7.2	8.4	9.6	10.8	12.0
ST 40-04	0.75	1.0	H (m)	26	23	22	21	20	18	16	12	9
ST 40-06	1.1	1.5		38	35	34	33	31	28	24	19	14
ST 40-08	1.5	2.0		52	47	45	44	41	37	31	25	18
ST 40-13	2.2	3.0		82	75	73	71	66	59	50	40	30
ST 40-17	3.0	4.0		108	98	96	94	87	79	70	58	46
ST 40-21	3.7	5.0		132	117	114	111	103	93	82	68	52
ST 40-23	4.0	5.5		148	134	131	127	118	108	95	79	60
ST 40-32	5.5	7.5		202	182	178	172	160	143	125	105	80
ST 40-42	7.5	10.0		265	239	232	225	208	188	163	135	105

Dimensions and Weights

Pump Type	Dimensions (mm)			Net Weight (kg)
	A	B	C	PUMP
ST 40-04	301	Rp 2" NPT 2"	98	2.8
ST 40-06	356		98	3.4
ST 40-08	418		98	4.0
ST 40-13	573		98	5.5
ST 40-17	697		98	6.6
ST 40-21	859		98	7.8
ST 40-23	959		98	9.4
ST 40-32	1260		98	12.0
ST 40-42	1650		98	15.5

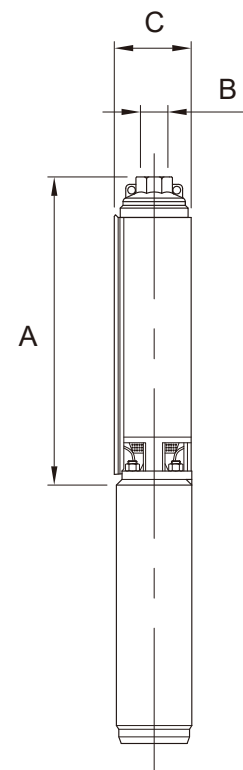

Performance Curves

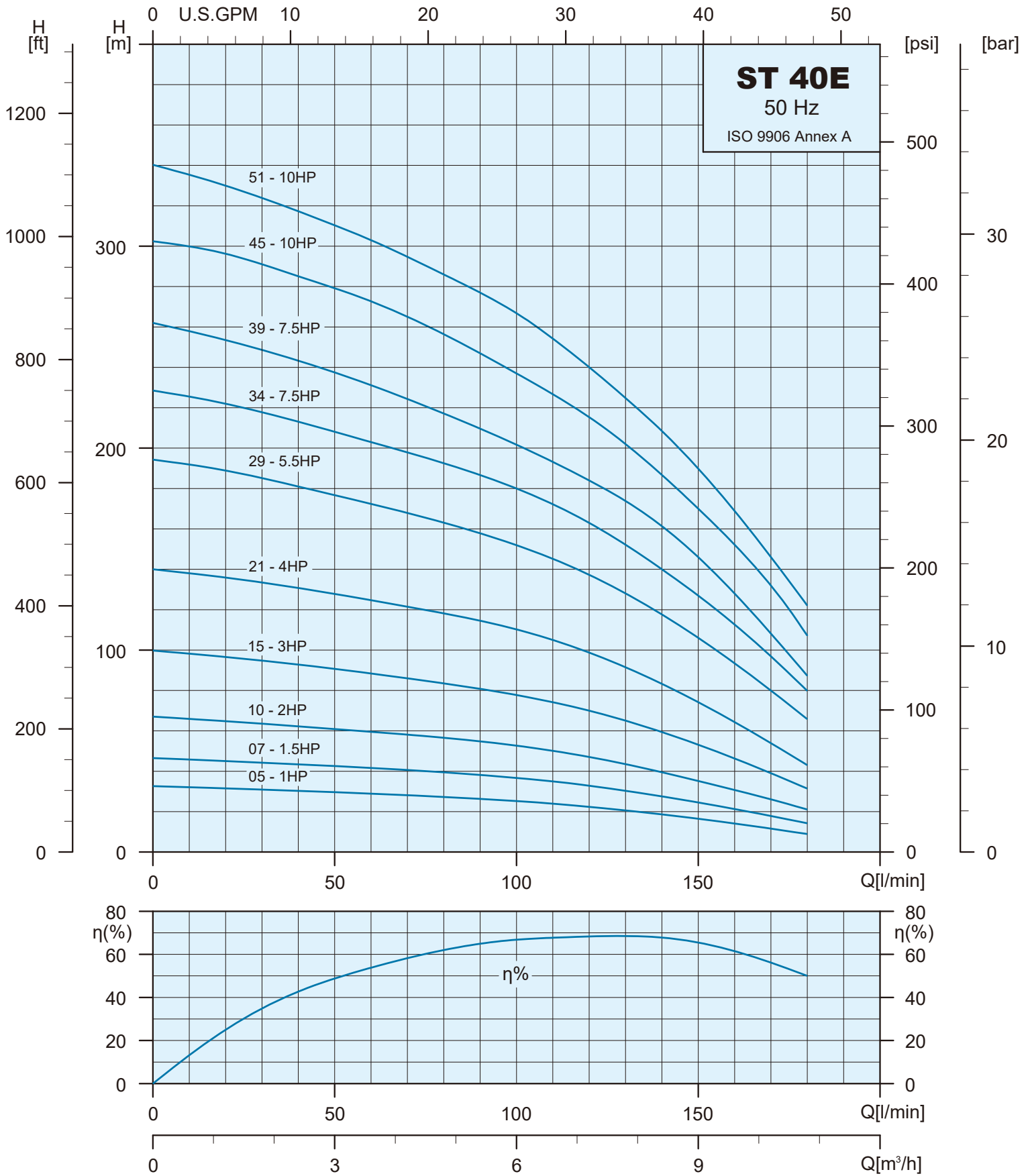

Specifications

Pump Type	Motor		Q=DELIVERY									
	kW	HP	l/min	0	80	90	100	120	140	160	180	200
			m ³ /h	0	4.8	5.4	6.0	7.2	8.4	9.6	10.8	12.0
ST 40E-05	0.75	1.0	H (m)	33	27	26	25	22	19	14	9	-
ST 40E-07	1.1	1.5		47	39	38	37	33	28	21	14	-
ST 40E-10	1.5	2.0		67	57	55	53	47	39	31	21	-
ST 40E-15	2.2	3.0		100	83	81	78	70	59	46	31	-
ST 40E-21	3.0	4.0		140	118	115	110	99	83	64	43	-
ST 40E-29	4.0	5.5		194	163	158	152	137	118	93	66	-
ST 40E-34	5.5	7.5		229	193	187	180	163	140	113	80	-
ST 40E-39	5.5	7.5		262	217	210	202	184	161	128	87	-
ST 40E-45	7.5	10.0		302	256	247	237	215	187	152	107	-
ST 40E-51	7.5	10.0		340	286	277	267	240	208	169	122	-

Dimensions and Weights

Pump Type	Dimensions (mm)			Net Weight (kg)
	A	B	C	PUMP
ST 40E-05	330	Rp 2" NPT 2"	98	3.2
ST 40E-07	395		98	3.8
ST 40E-10	485		98	4.6
ST 40E-15	640		98	6.1
ST 40E-21	865		98	8.2
ST 40E-29	1150		98	10.7
ST 40E-34	1325		98	13.2
ST 40E-39	1480		98	14.5
ST 40E-45	1745		98	17.1
ST 40E-51	1930		98	18.6

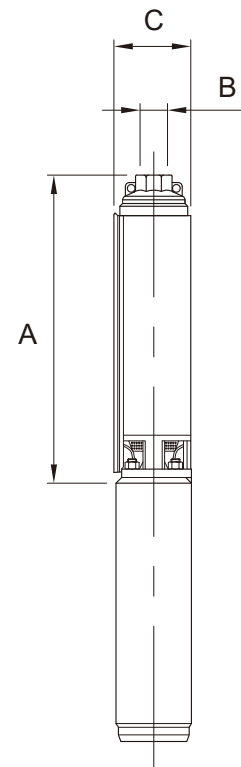

Performance Curves

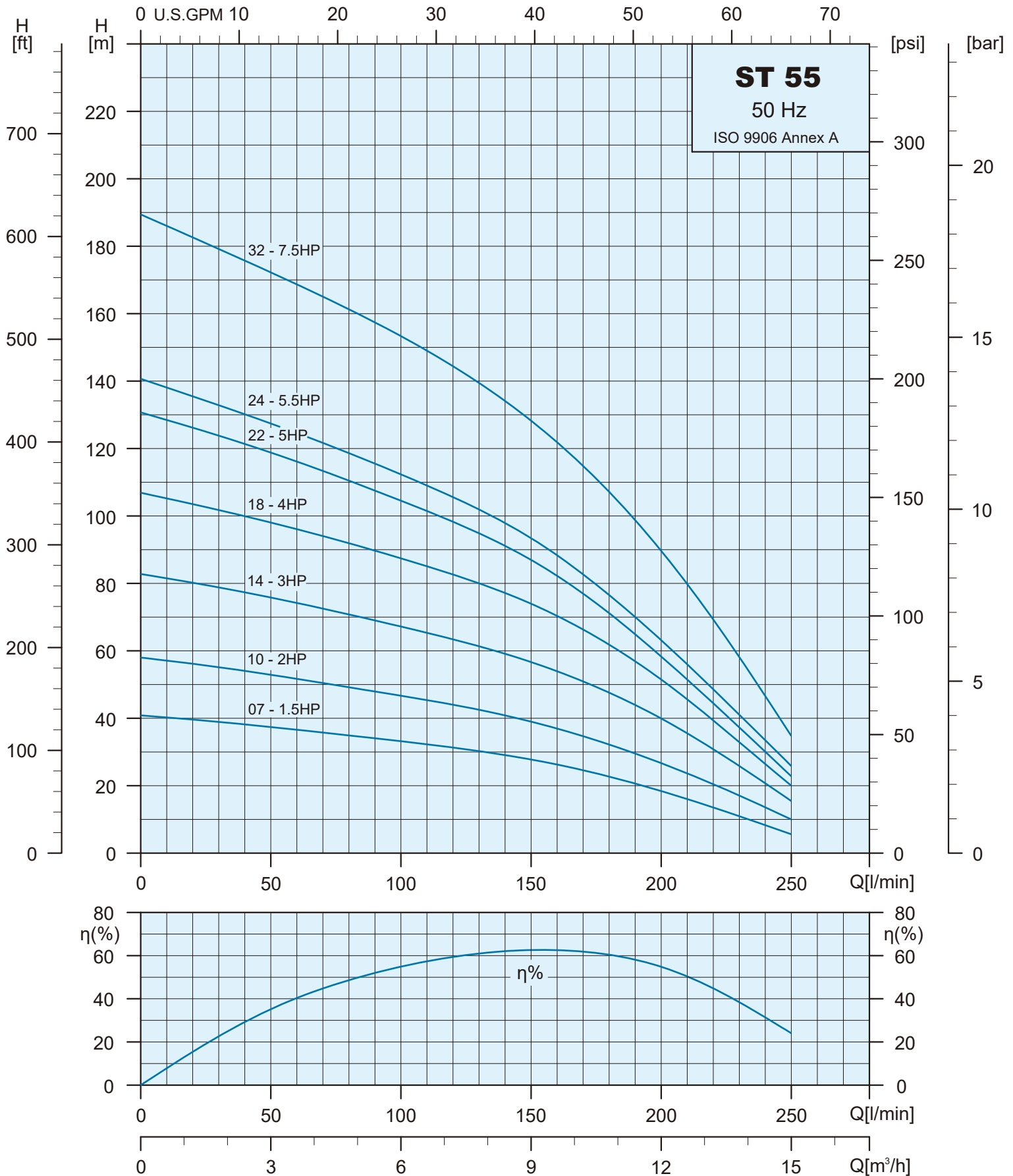

Specifications

Pump Type	Motor		Q=DELIVERY											
	kW	HP	l/min	0	80	90	100	120	140	160	180	200	220	240
			m ³ /h	0	4.8	5.4	6.0	7.2	8.4	9.6	10.8	12.0	13.2	14.4
ST 55-07	1.1	1.5	H (m)	41	35	34	33	32	29	26	23	18	14	8
ST 55-10	1.5	2.0		58	49	48	47	44	41	37	32	27	20	13
ST 55-14	2.2	3.0		83	71	69	67	63	58	54	48	40	31	20
ST 55-18	3.0	4.0		107	92	90	87	83	77	70	62	52	39	26
ST 55-22	3.7	5.0		131	110	107	104	98	91	82	71	58	45	30
ST 55-24	4.0	5.5		141	118	116	113	106	97	88	77	63	49	33
ST 55-32	5.5	7.5		189	162	157	153	144	134	122	107	90	70	47

Dimensions and Weights

Pump Type	Dimensions (mm)			Net Weight (kg)
	A	B	C	PUMP
ST 55-07	537	Rp 2" NPT 2"	98	5.3
ST 55-10	693		98	6.7
ST 55-14	901		98	8.5
ST 55-18	1185		98	11.4
ST 55-22	1410		98	13.3
ST 55-24	1515		98	14.2
ST 55-32	1932		98	18.0

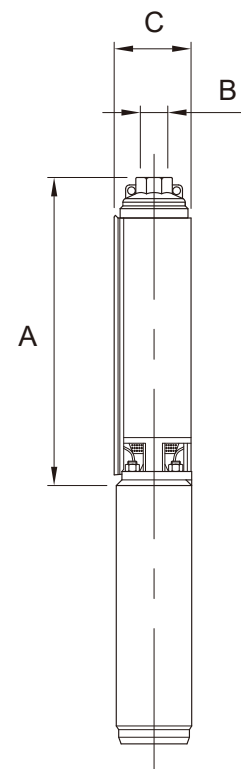

Performance Curves

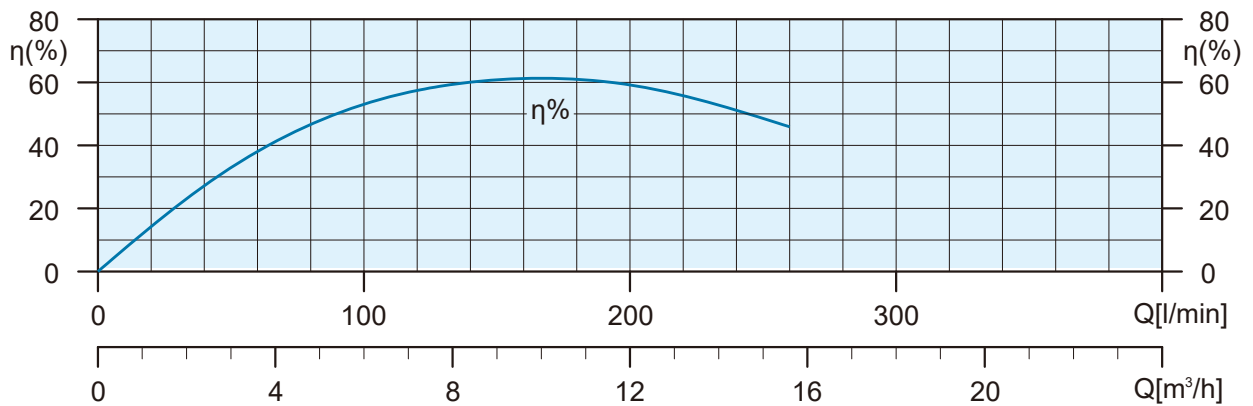
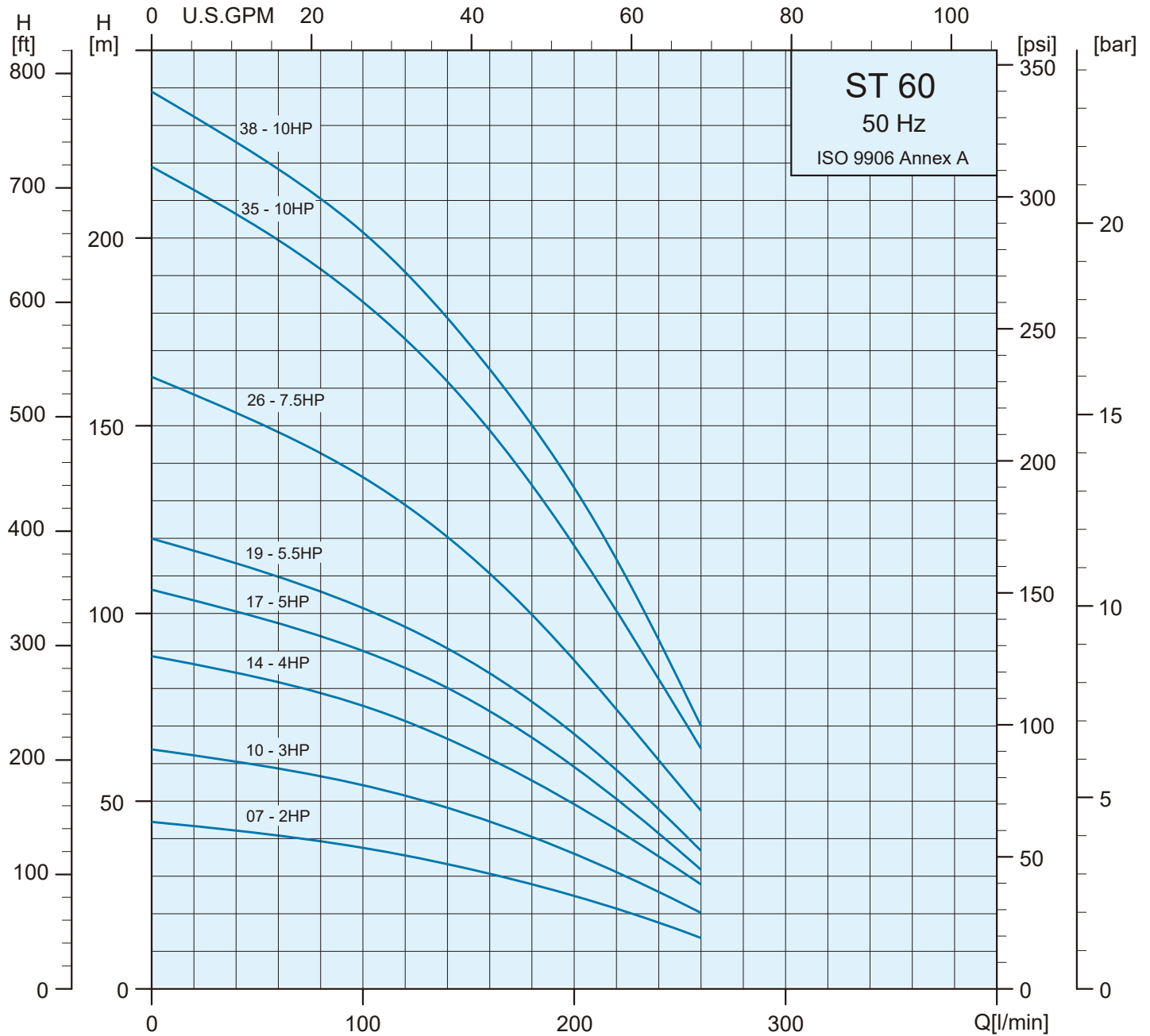

Specifications

Pump Type	Motor		Q=DELIVERY										
	kW	HP	l/min	0	100	120	140	160	180	200	220	240	260
			m ³ /h	0	6.0	7.2	8.4	9.6	10.8	12.0	13.2	14.4	15.6
ST 60-07	1.5	2.0	H (m)	45	37	36	33	31	28	25	22	18	14
ST 60-10	2.2	3.0		64	54	52	48	44	41	36	32	26	20
ST 60-14	3.0	4.0		89	76	72	67	62	56	49	43	35	28
ST 60-17	3.7	5.0		107	90	86	80	74	67	59	51	42	32
ST 60-19	4.0	5.5		120	102	97	91	89	76	68	58	48	37
ST 60-26	5.5	7.5		163	136	129	120	111	100	87	75	61	48
ST 60-35	7.5	10.0		219	183	173	162	149	134	118	111	82	64
ST 60-38	7.5	10.0		239	201	191	178	165	150	134	114	93	70

Dimensions and Weights

Pump Type	Dimensions (mm)			Net Weight (kg)
	A	B	C	PUMP
ST 60-07	534	Rp 2" NPT 2"	98	5.3
ST 60-10	690		98	6.7
ST 60-14	989		98	8.6
ST 60-17	1092		98	10.1
ST 60-19	1233		98	12.0
ST 60-26	1620		98	15.3
ST 60-35	2165		98	19.6
ST 60-38	2322		98	21.5

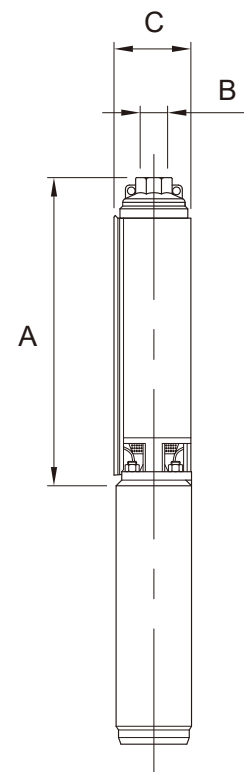

Performance Curves

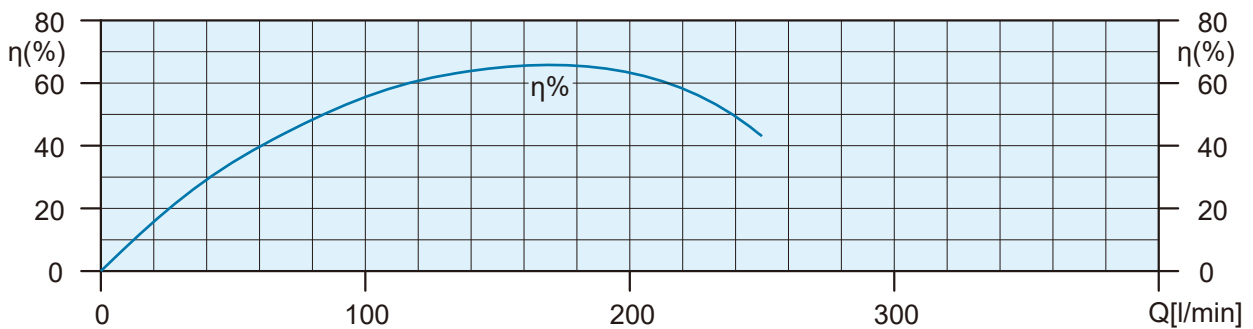
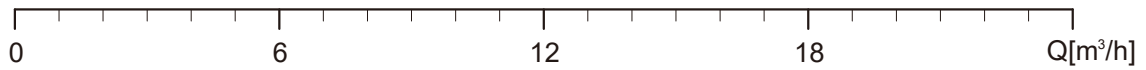
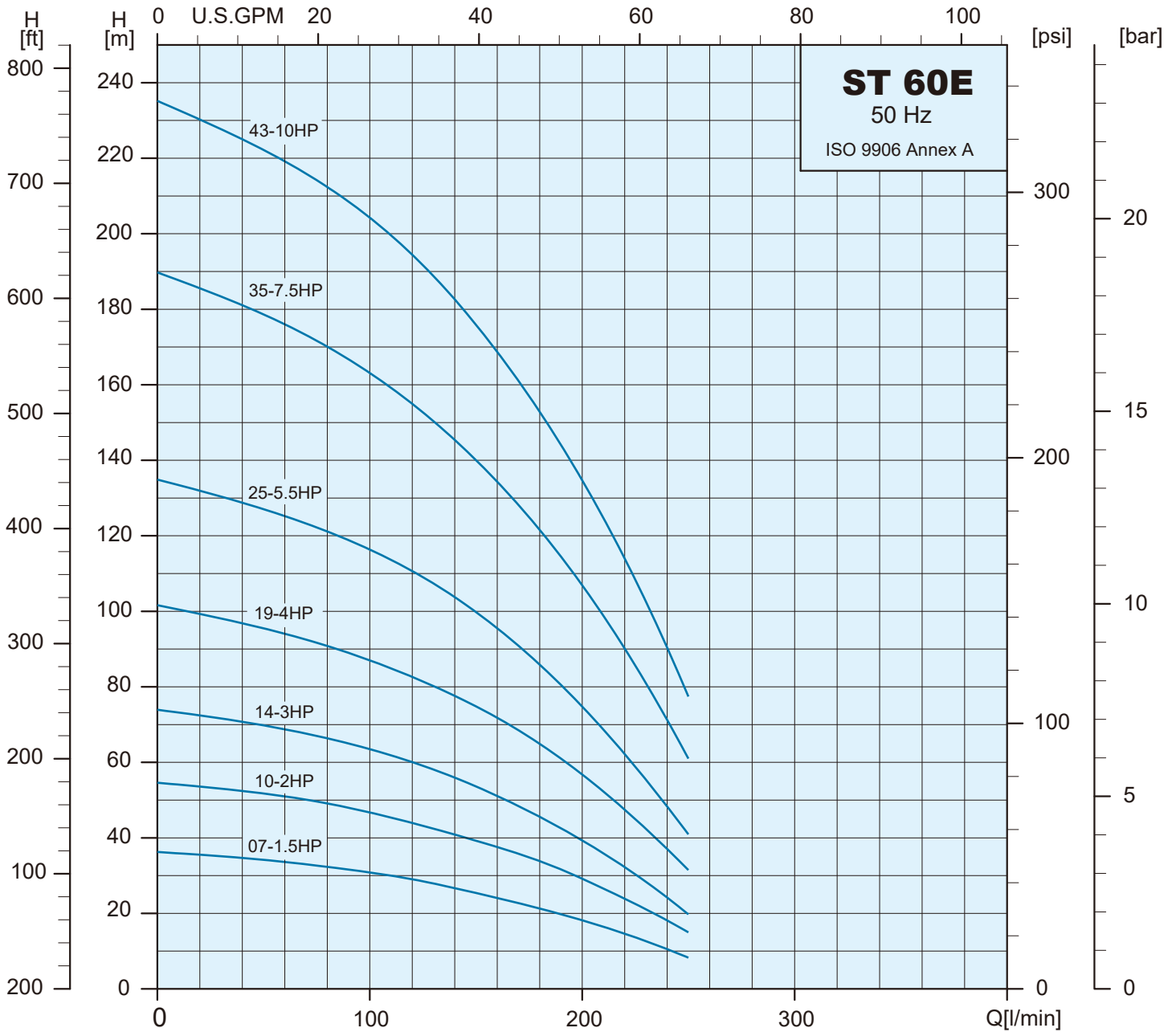

Specifications

Pump Type	Motor		Q=DELIVERY										
	kW	HP	l/min	0	90	100	120	140	160	180	200	220	240
			m ³ /h	0	5.4	6.0	7.2	8.4	9.6	10.8	12.0	13.2	14.4
ST 60E-07	1.1	1.5	H (m)	36	—	31	29	27	24	21	18	15	11
ST 60E-10	1.5	2.0		55	—	47	44	41	38	34	29	24	18
ST 60E-14	2.2	3.0		74	—	64	60	56	51	46	39	32	24
ST 60E-19	3.0	4.0		102	—	87	83	78	72	65	57	48	37
ST 60E-25	4.0	5.5		135	—	116	111	104	96	86	75	62	48
ST 60E-35	5.5	7.5		190	—	163	155	145	134	122	107	90	71
ST 60E-43	7.5	10.0		235	—	204	194	183	169	153	135	114	90

Dimensions and Weights

Pump Type	Dimensions (mm)			Net Weight (kg)
	A	B	C	PUMP
ST 60E-07	540	Rp 2" NPT 2"	98	4.9
ST 60E-10	695		98	6.3
ST 60E-14	905		98	8.1
ST 60E-19	1240		98	11.0
ST 60E-25	1570		98	14.3
ST 60E-35	2165		98	19.8
ST 60E-43	2585		98	24.0

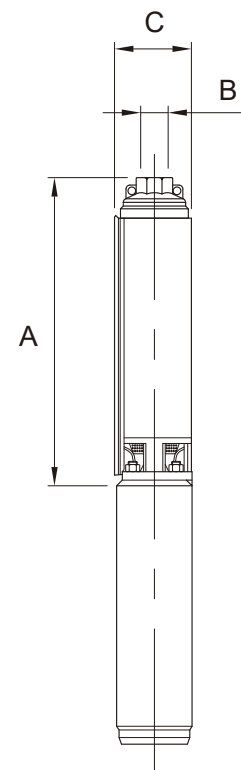

Performance Curves

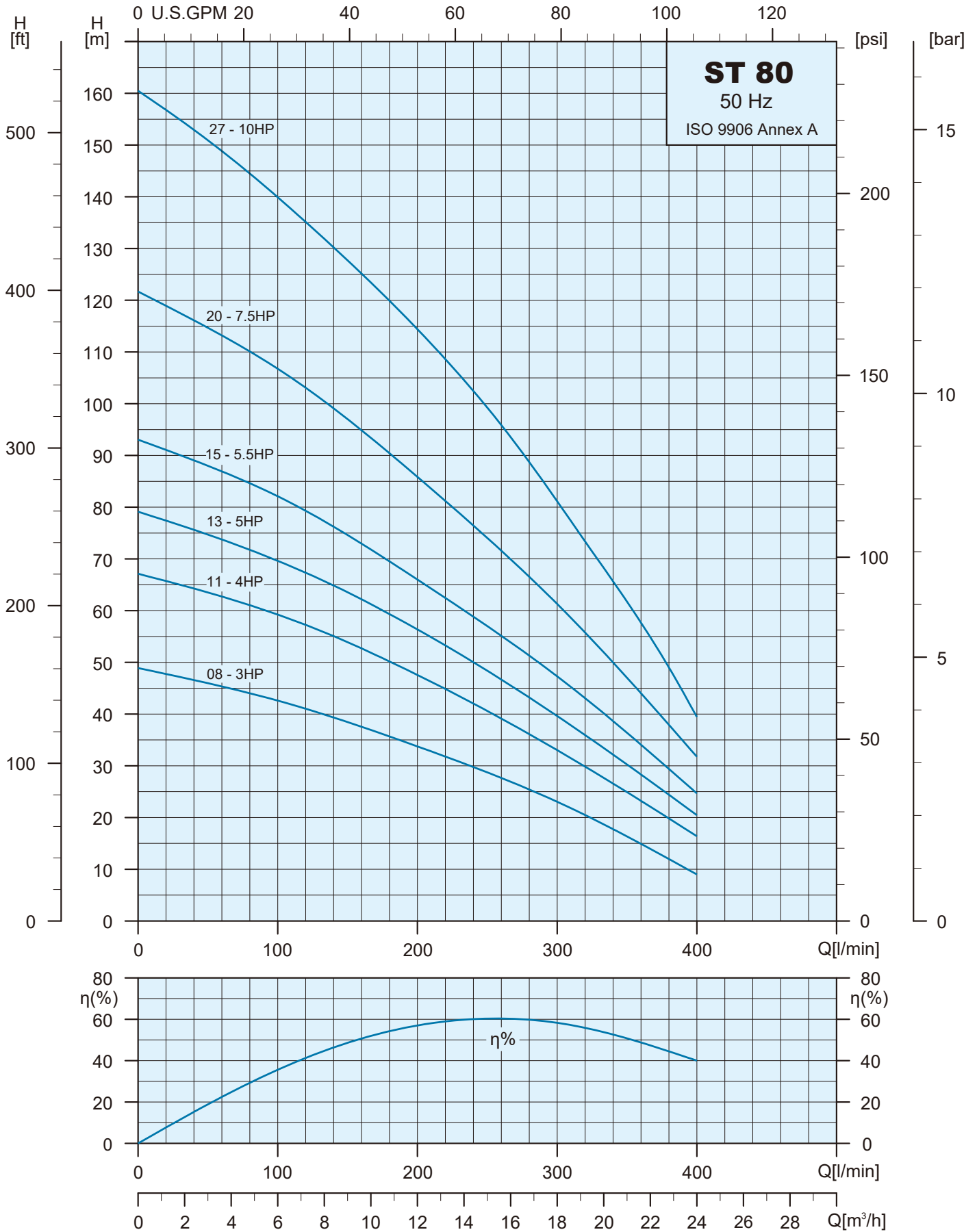

Specifications

Pump Type	Motor		Q=DELIVERY															
	kW	HP	l/min	0	140	160	180	200	220	240	260	280	300	320	340	360	380	400
			m ³ /h	0	8.4	9.6	10.8	12.0	13.2	14.4	15.6	16.8	18.0	19.2	20.4	21.6	22.8	24.0
ST 80-08	2.2	3.0	H (m)	49	39	38	36	34	32	30	28	25	23	20	18	15	12	9
ST 80-11	3.0	4.0		67	55	53	50	48	45	42	39	36	33	30	27	23	20	16
ST 80-13	3.7	5.0		79	65	62	59	56	53	50	47	43	40	36	32	28	24	20
ST 80-15	4.0	5.5		93	76	73	70	66	62	59	55	51	47	43	39	34	29	25
ST 80-20	5.5	7.5		122	99	95	90	86	81	76	72	67	61	56	50	44	38	32
ST 80-27	7.5	10.0		161	130	125	120	114	109	102	96	89	81	73	65	57	49	39

Dimensions and Weights

Pump Type	Dimensions (mm)			Net Weight (kg)
	A	B	C	PUMP
ST 80-08	676	Rp 2" NPT 2"	98	6.3
ST 80-11	880		98	8.1
ST 80-13	1013		98	9.3
ST 80-15	1149		98	10.5
ST 80-20	1543		98	13.5
ST 80-27	2020		98	18.5

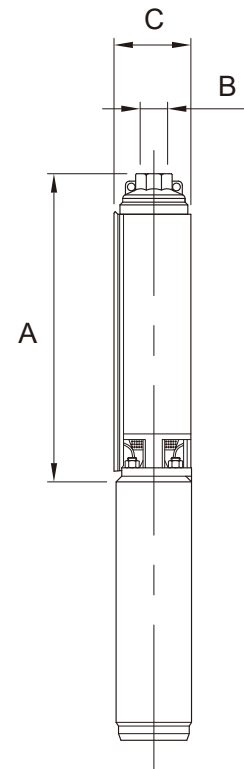

Performance Curves

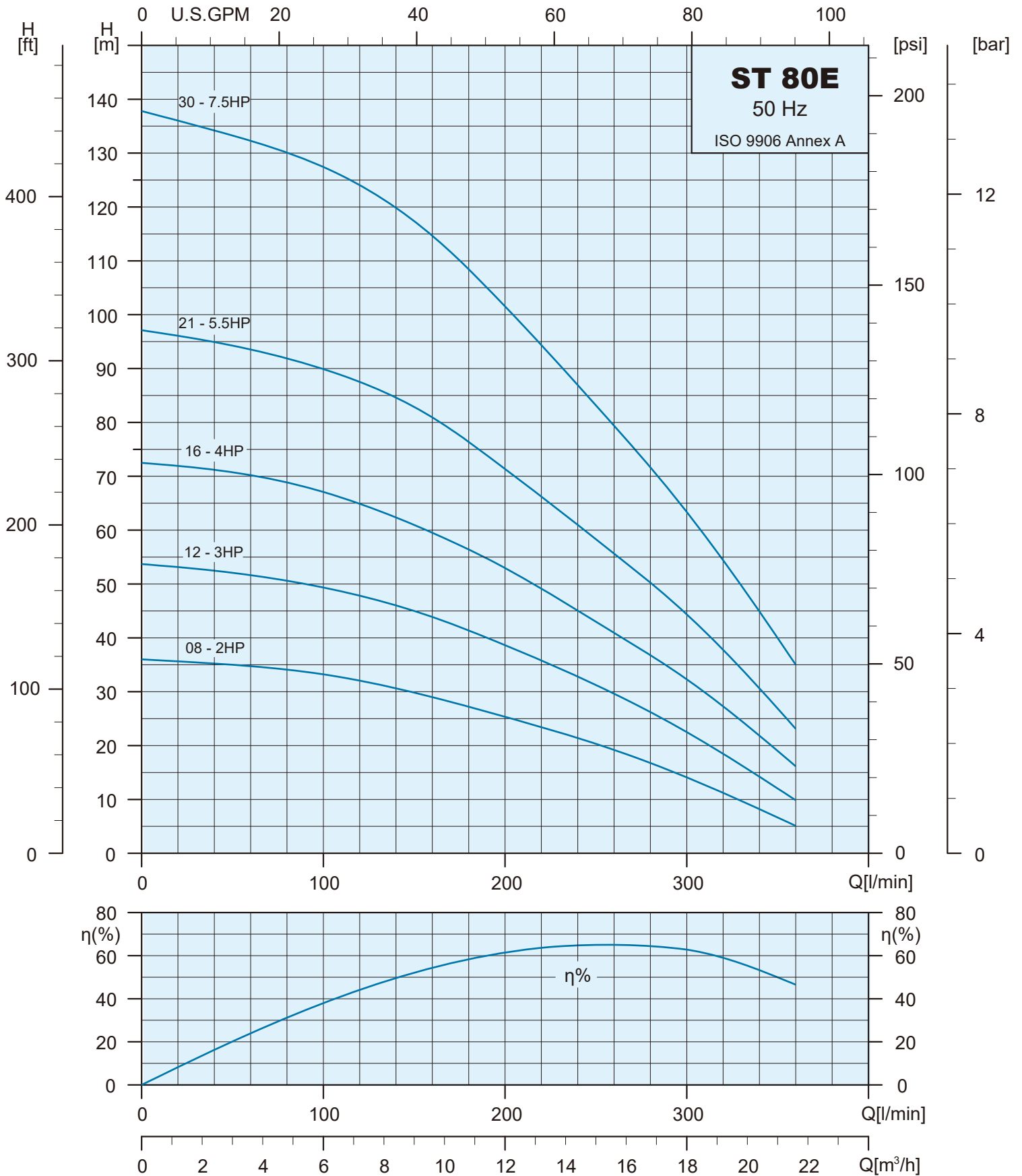

Specifications

Pump Type	Motor		Q=DELIVERY													
	kW	HP	l/min	0	140	160	180	200	220	240	260	280	300	320	340	360
			m ³ /h	0	8.4	9.6	10.8	12.0	13.2	14.4	15.6	16.8	18.0	19.2	20.4	21.6
ST 80E-08	1.5	2.0	H (m)	36	30.5	29	27	25	23	21	19	16.5	14	11	8	5
ST 80E-12	2.2	3.0		54	46	44	41	38.5	35.5	32.5	29.5	26	22.5	18	14	10
ST 80E-16	3.0	4.0		72.5	62	59.5	56	53	49	45	41	36.5	32	27	21	16
ST 80E-21	4.0	5.5		97	84.5	81	76	71	66	61	55.5	50	44	37.5	30	23
ST 80E-30	5.5	7.5		138	120	114.5	108	101.5	94	87	79	71.5	63	54	44.5	34.5

Dimensions and Weights

Pump Type	Dimensions (mm)			Net Weight (kg)
	A	B	C	PUMP
ST 80E-08	680	Rp 2" NPT 2"	98	6.1
ST 80E-12	950		98	8.4
ST 80E-16	1220		98	10.8
ST 80E-21	1610		98	14.7
ST 80E-30	2225		98	20.1

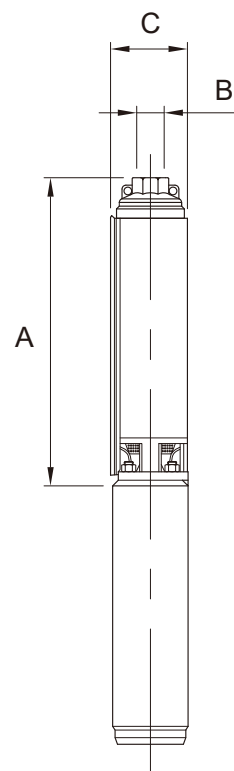

Performance Curves

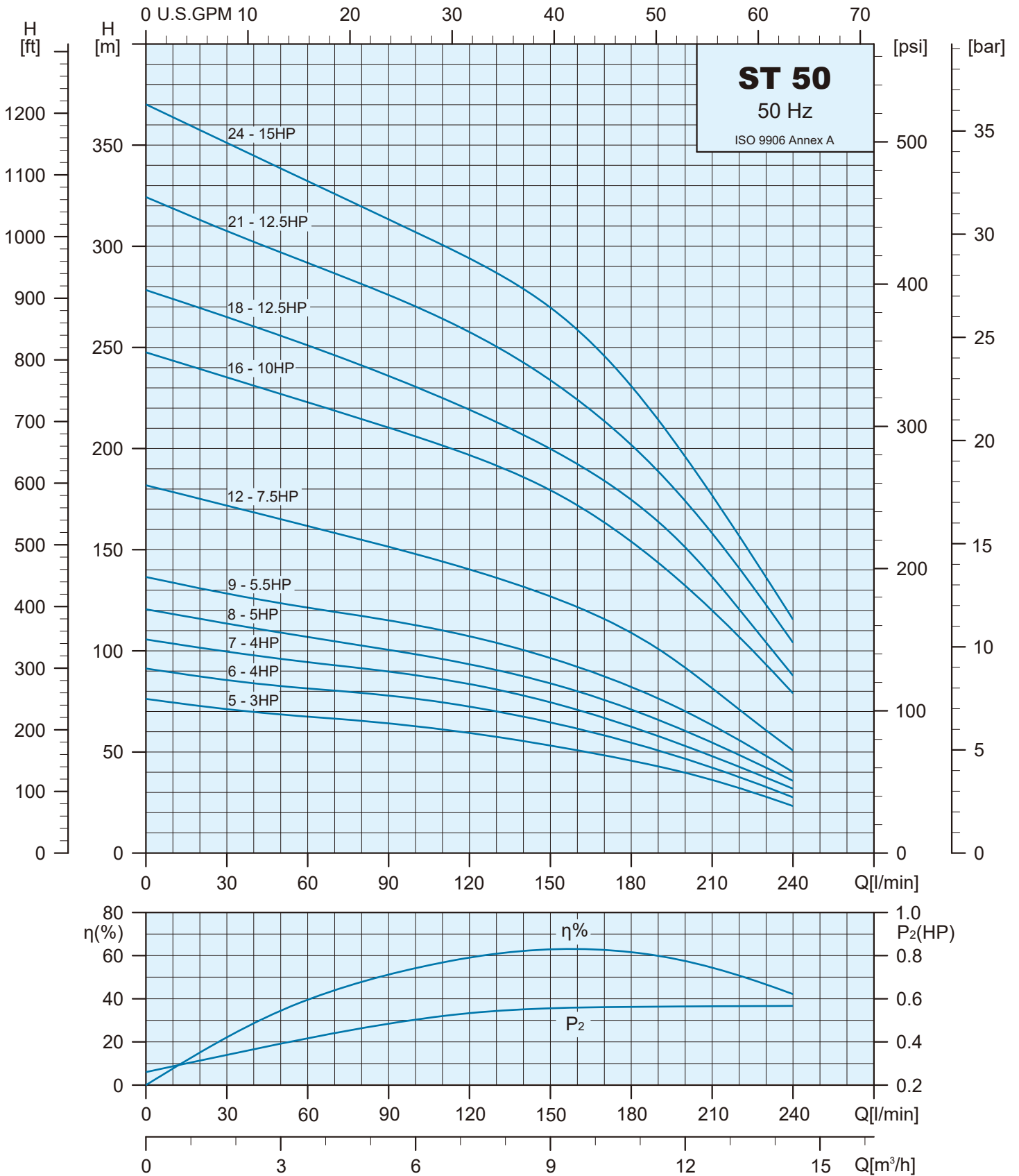

Specifications

Pump Type	Motor		Q=DELIVERY											
	kW	HP	l/min	0	60	80	100	120	140	160	180	200	220	240
			m ³ /h	0	3.6	4.8	6.0	7.2	8.4	9.6	10.8	12.0	13.2	14.4
ST 50-05	2.2	3.0	H (m)	77	67	65	62	59	55	51	45	39	32	23
ST 50-06	3.0	4.0		92	81	79	76	72	67	61	54	46	37	27
ST 50-07	3.0	4.0		106	94	91	88	84	79	71	62	53	42	32
ST 50-08	3.7	5.0		121	107	102	98	93	87	80	71	60	48	35
ST 50-09	4.0	5.5		137	121	117	112	107	100	92	82	70	56	40
ST 50-12	5.5	7.5		182	161	155	148	140	131	121	109	91	71	50
ST 50-16	7.5	10.0		248	223	214	206	196	186	172	154	132	107	79
ST 50-18	9.3	12.5		279	251	241	230	219	206	192	174	151	120	87
ST 50-21	9.3	12.5		325	292	281	270	257	242	224	201	174	141	104
ST 50-24	11.0	15.0		371	332	319	307	294	279	258	231	196	156	115

Dimensions and Weights

Pump Type	Motor Type	Dimensions (mm)					Net Weight (kg)
		A	B	C	C*	C**	PUMP
ST 50-05	4"	539	Rp 3" NPT 3"	138	—	—	10.3
ST 50-06		577		138	—	—	11.1
ST 50-07		615		138	—	—	11.8
ST 50-08		653		138	—	—	12.5
ST 50-09		691		138	—	—	13.1
ST 50-12		805		138	—	—	15.0
ST 50-16		957		138	—	—	17.7
ST 50-12	6"	819	—	141	141	15.9	
ST 50-16		971	—	141	141	18.7	
ST 50-18		1047	—	141	141	20.0	
ST 50-21		1161	—	141	141	21.9	
ST 50-24		1275	—	141	141	24.0	

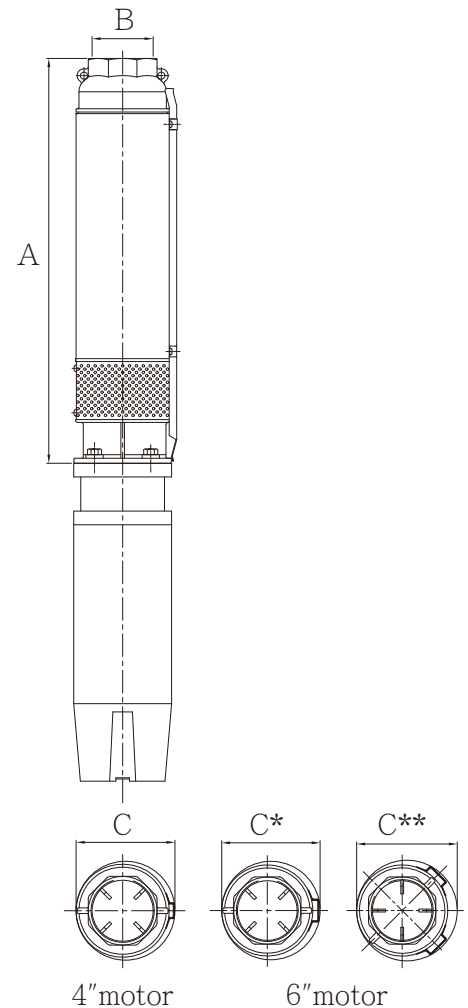

Performance Curves

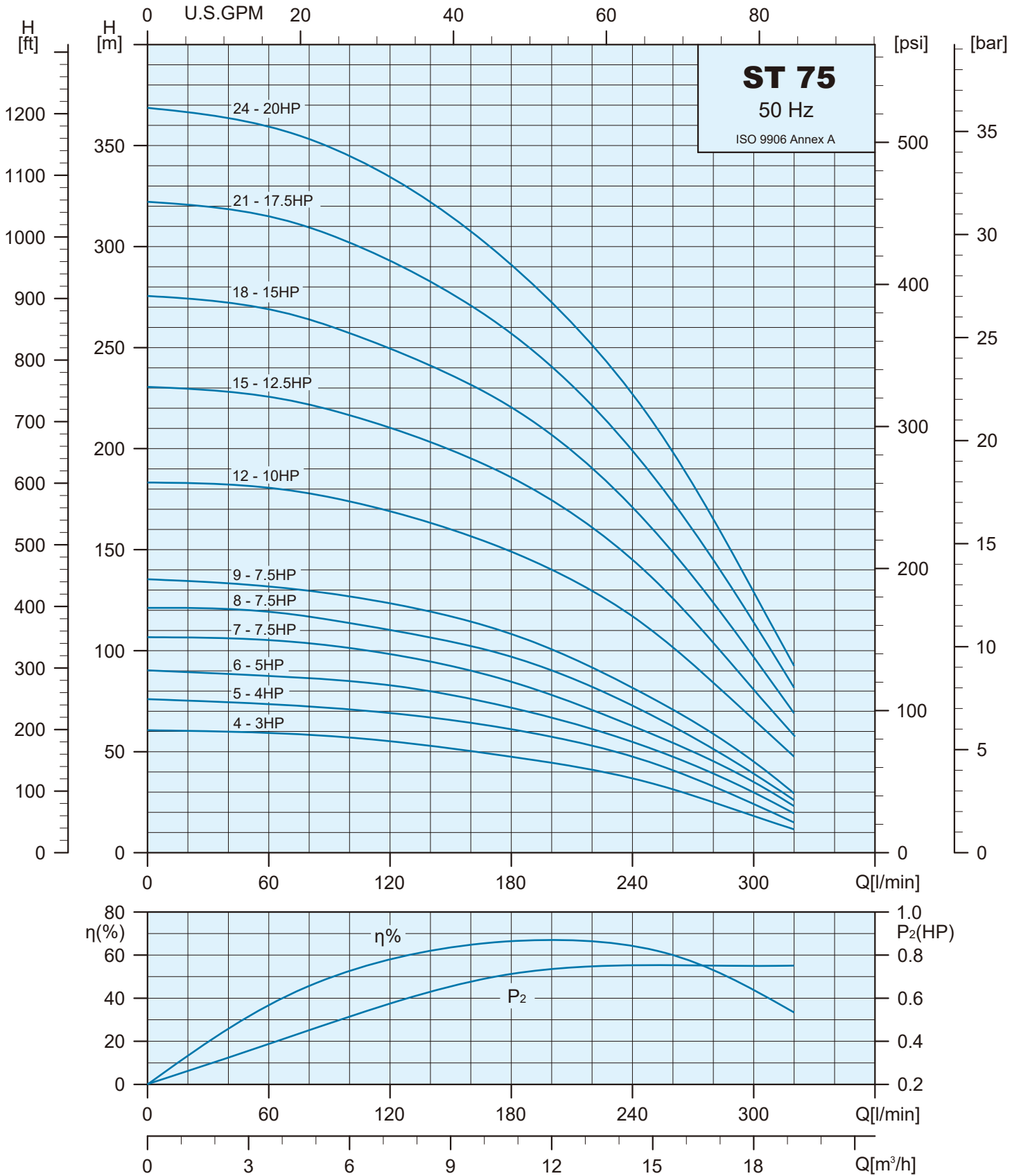

Specifications

Pump Type	Motor		Q=DELIVERY												
	kW	HP	l/min	0	120	140	160	180	200	220	240	260	280	300	320
			m ³ /h	0	7.2	8.4	9.6	10.8	12.0	13.2	14.4	15.6	16.8	18.0	19.2
ST 75-04	2.2	3.0	H (m)	61	55	53	50	47	44	41	37	31	25	18	11
ST 75-05	3.0	4.0		77	69	67	64	61	57	53	47	40	33	24	15
ST 75-06	3.7	5.0		91	82	80	76	71	67	61	55	47	39	29	19
ST 75-07	5.5	7.5		107	98	94	90	84	78	70	62	54	45	35	23
ST 75-08	5.5	7.5		122	110	106	102	97	90	82	73	62	51	39	26
ST 75-09	5.5	7.5		136	123	119	114	108	101	91	81	71	59	45	29
ST 75-12	7.5	10.0		184	169	163	156	149	140	129	117	101	84	66	47
ST 75-15	9.3	12.5		231	210	203	195	185	174	161	145	126	104	80	57
ST 75-18	11.0	15.0		276	249	241	231	220	206	190	171	148	123	97	69
ST 75-21	13.0	17.5		323	293	282	271	257	240	221	199	173	145	114	81
ST 75-24	15.0	20.0		369	334	322	307	291	272	251	227	198	165	129	92

Dimensions and Weights

Pump Type	Motor Type	Dimensions (mm)					Net Weight (kg)	
		A	B	C	C*	C**	PUMP	
ST 75-04	4"	501	Rp 3" NPT 3"	138	—	—	9.6	
ST 75-05		539		138	—	—	10.3	
ST 75-06		577		138	—	—	11.0	
ST 75-07		615		138	—	—	11.7	
ST 75-08		653		138	—	—	12.5	
ST 75-09		691		138	—	—	13.1	
ST 75-12		805		138	—	—	15.0	
ST 75-07		6"		629	—	141	141	12.5
ST 75-08				667	—	141	141	13.2
ST 75-09	705		—	141	141	13.9		
ST 75-12	819		—	141	141	15.8		
ST 75-15	933		—	141	141	17.8		
ST 75-18	1047		—	141	141	19.9		
ST 75-21	1161		—	141	141	21.8		
ST 75-24	1275	—	141	141	23.8			

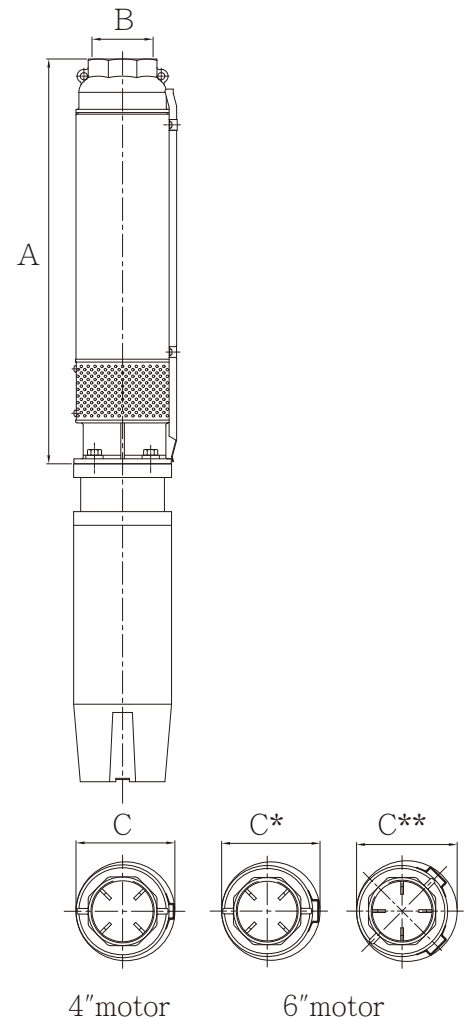

Performance Curves

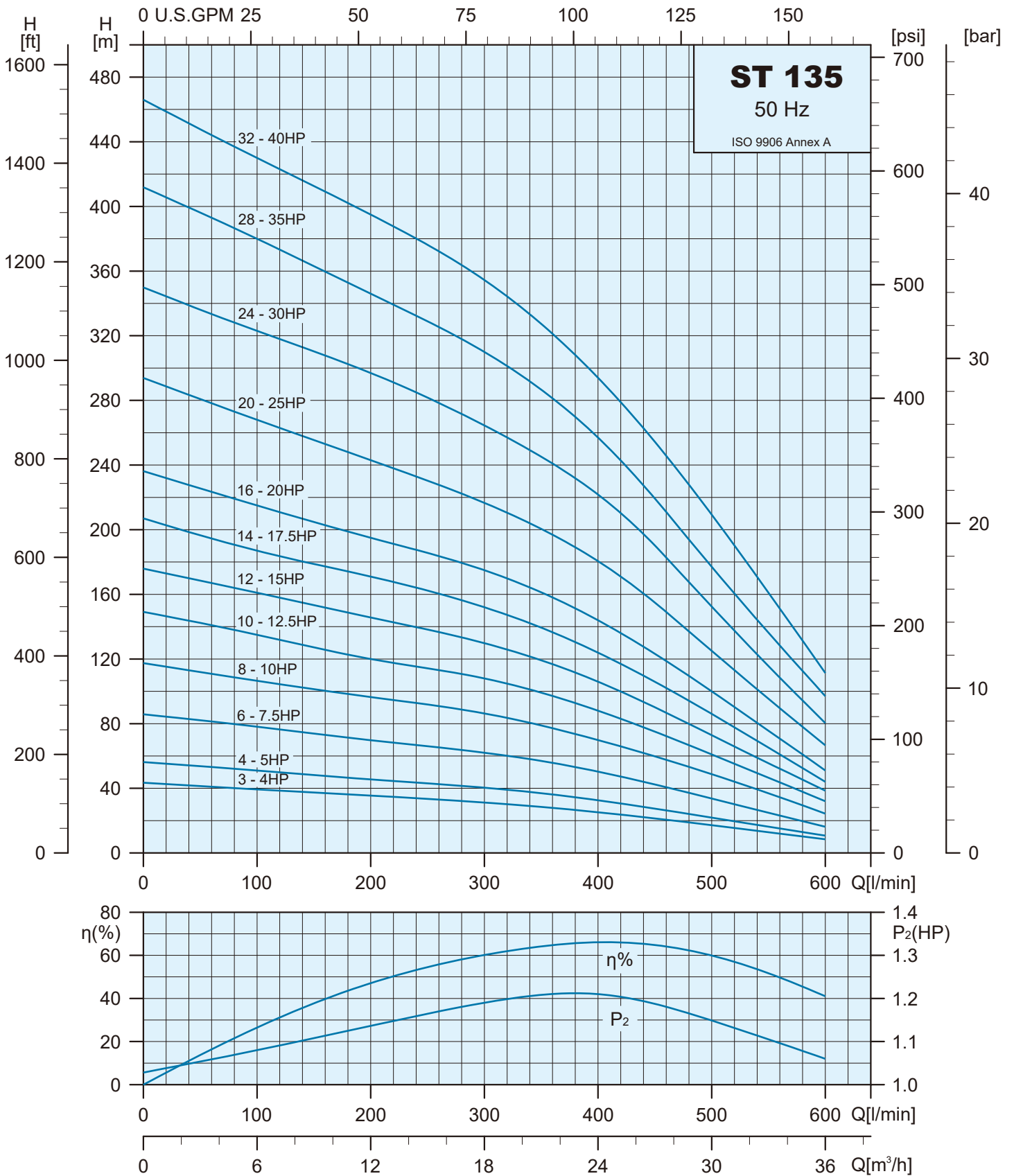

Specifications

Pump Type	Motor		Q=DELIVERY												
	kW	HP	l/min	0.0	200	240	280	320	360	400	440	480	520	560	600
			m ³ /h	0.0	12.0	14.4	16.8	19.2	21.6	24.0	26.4	28.8	31.2	33.6	36.0
ST 135-03	3.0	4.0	H (m)	44	36	34	32	30	28	25	22	19	15	12	8
ST 135-04	3.7	5.0		57	45	43	41	39	36	32	28	24	19	15	10
ST 135-06	5.5	7.5		86	69	66	63	60	55	50	44	37	30	23	16
ST 135-08	7.5	10.0		118	96	92	88	83	77	70	62	53	44	34	24
ST 135-10	9.3	12.5		150	120	115	110	105	97	88	77	66	55	43	32
ST 135-12	11.0	15.0		176	145	139	133	126	116	106	93	80	66	52	38
ST 135-14	13.0	17.5		207	171	164	156	147	136	124	109	94	77	61	44
ST 135-16	15.0	20.0		237	195	187	179	170	158	144	127	109	90	70	51
ST 135-20	18.5	25.5		294	243	233	222	210	197	180	160	137	113	89	66
ST 135-24	22.0	30.0		350	297	285	271	257	241	221	197	167	137	108	80
ST 135-28	26.0	35.0		412	346	332	318	301	281	257	227	194	160	128	97
ST 135-32	30.0	40.0		466	395	380	363	344	321	294	262	228	190	151	111

Dimensions and Weights

Pump Type	Motor Type	Dimensions (mm)					Net Weight (kg)
		A	B	C	C*	C**	PUMP
ST 135-03	4"	520	Rp 3" NPT 3"	138	—	—	9.9
ST 135-04		577		138	—	—	10.8
ST 135-06		691		138	—	—	12.6
ST 135-08		805		138	—	—	14.3
ST 135-06	6"	705		—	141	144	13.5
ST 135-08		819		—	141	144	15.2
ST 135-10		933		—	141	144	17.0
ST 135-12		1047		—	141	144	18.9
ST 135-14		1161		—	141	144	20.7
ST 135-16		1275		—	141	144	22.6
ST 135-20		1555		—	141	144	27.0
ST 135-24		1783		—	141	144	30.7
ST 135-28		2063		—	141	144	35.1
ST 135-32		2291		—	141	144	38.9

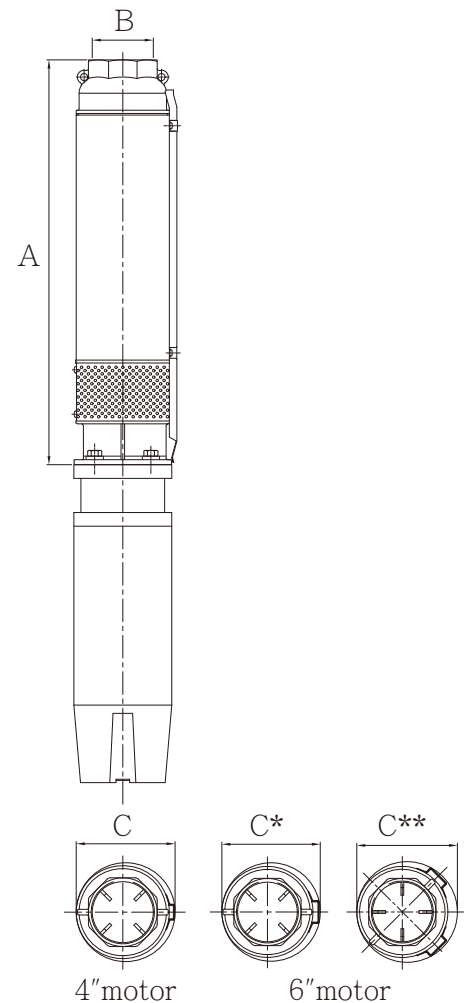

Performance Curves

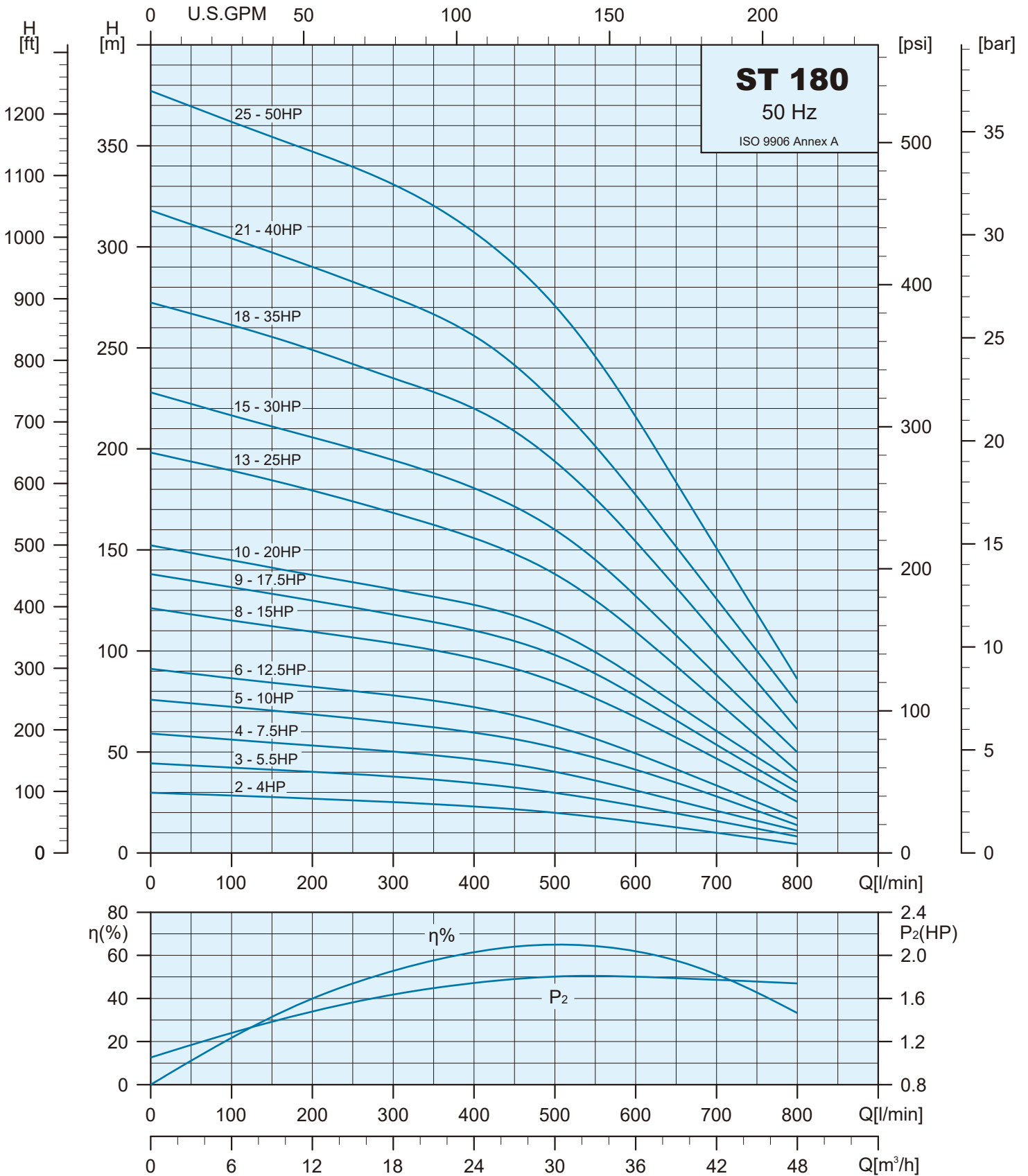

Specifications

Pump Type	Motor		Q=DELIVERY												
	kW	HP	l/min	0	300	350	400	450	500	550	600	650	700	750	800
			m ³ /h	0	18.0	21.0	24.0	27.0	30.0	33.0	36.0	39.0	42.0	45.0	48.0
ST 180-02	3.0	4.0	H (m)	30	25	24	23	21	20	17	15	12	10	7	4
ST 180-03	4.0	5.5		45	38	36	34	32	29	26	23	19	16	12	8
ST 180-04	5.5	7.5		59	50	48	46	43	40	36	31	26	21	16	11
ST 180-05	7.5	10.0		76	64	62	59	56	52	47	41	35	28	21	13
ST 180-06	9.3	12.5		92	78	75	72	68	63	56	49	41	33	25	17
ST 180-08	11.0	15.0		122	103	100	96	91	84	76	67	57	46	36	25
ST 180-09	13.0	17.5		138	118	114	110	105	98	88	77	65	53	41	30
ST 180-10	15.0	20.0		153	130	127	123	117	110	99	87	73	60	47	35
ST 180-13	18.5	25.0		199	168	162	156	148	138	125	109	92	75	58	40
ST 180-15	22.0	30.0		228	194	188	180	171	160	145	127	107	88	69	50
ST 180-18	26.0	35.0		273	235	228	220	208	194	175	154	131	108	84	61
ST 180-21	30.0	40.0		318	275	266	256	241	223	201	177	151	125	100	74
ST 180-25	37.0	50.0		378	331	320	307	291	271	245	216	183	151	118	86

Dimensions and Weights

Pump Type	Motor Type	Dimensions (mm)					Net Weight (kg)
		A	B	C	C*	C**	PUMP
ST 180-02	4"	469	Rp 3" NPT 3"	138	—	—	8.9
ST 180-03		529		138	—	—	9.9
ST 180-04		589		138	—	—	10.7
ST 180-05		649		138	—	—	11.8
ST 180-04	6"	603		—	141	144	11.6
ST 180-05		663		—	141	144	12.6
ST 180-06		723		—	141	144	13.6
ST 180-08		843		—	141	144	15.5
ST 180-09		903		—	141	144	16.5
ST 180-10		963		—	141	144	17.4
ST 180-13		1143		—	141	144	20.3
ST 180-15		1263		—	141	144	22.2
ST 180-18		1495		—	141	144	25.9
ST 180-21		1675		—	141	144	28.6
ST 180-25		1915		—	141	144	32.5

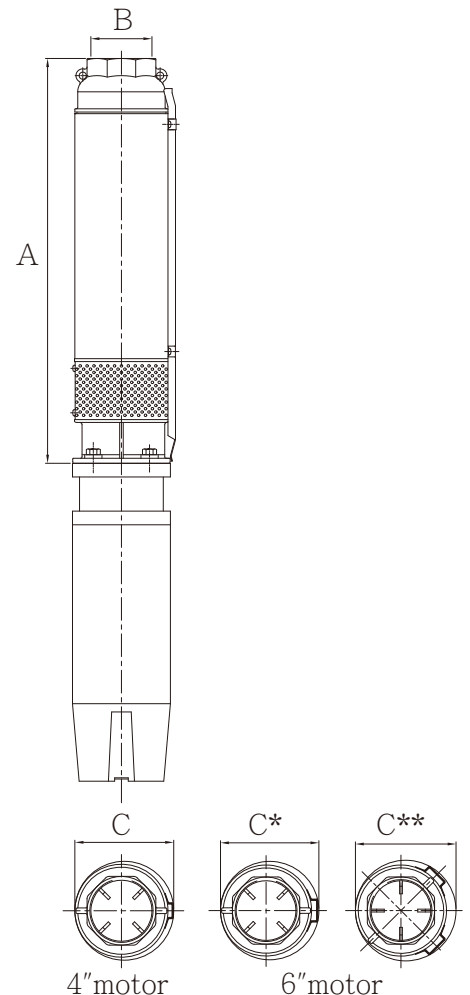

Performance Curves

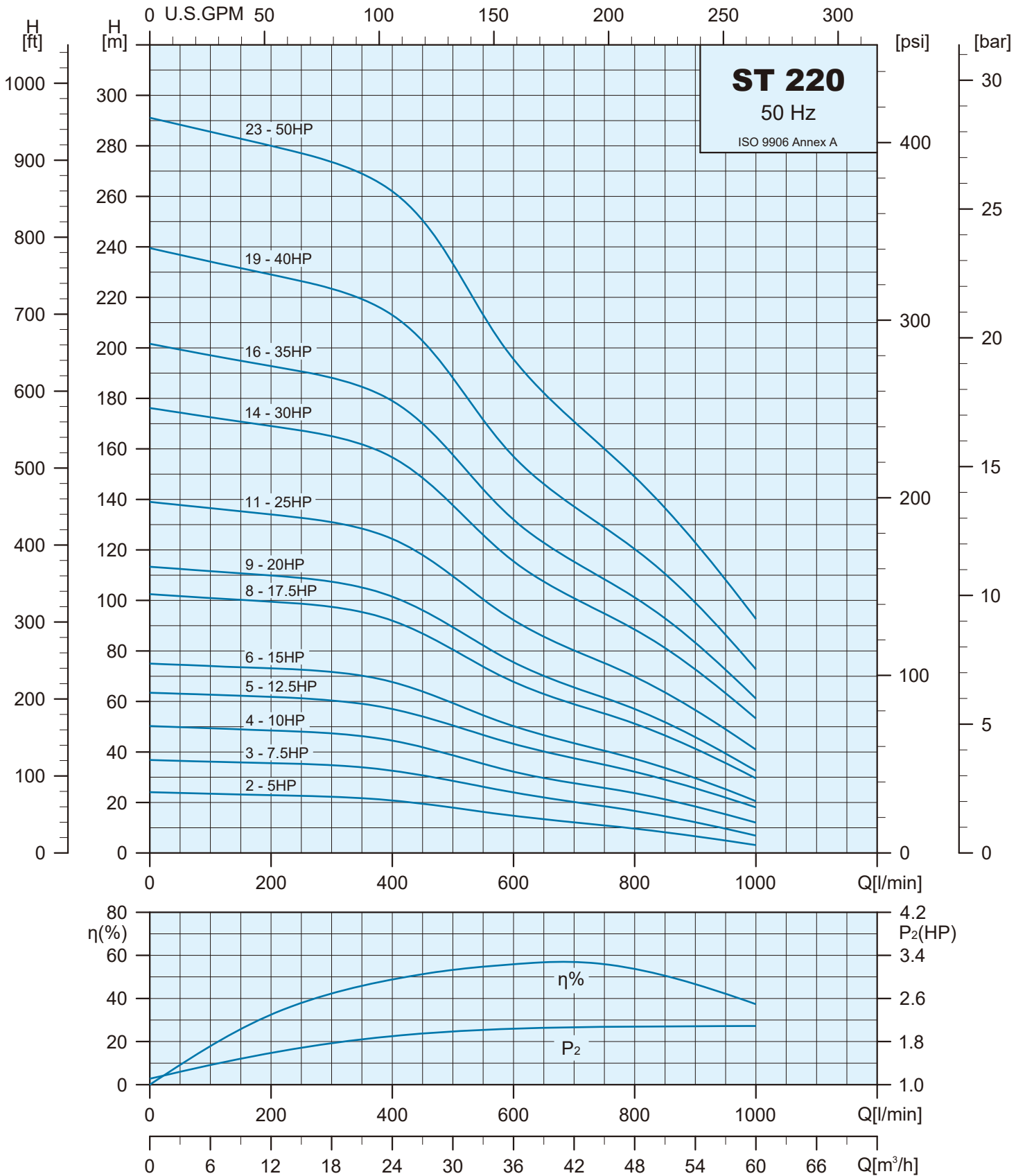

Specifications

Pump Type	Motor		Q=DELIVERY												
	kW	HP	l/min	0	400	450	500	550	600	650	700	750	800	900	1000
			m3/h	0	24.0	27.0	30.0	33.0	36.0	39.0	42.0	45.0	48.0	54.0	60.0
ST 220-02	3.7	5.0	H (m)	25	21	19	18	16	14	13	13	11	9	6	3
ST 220-03	5.5	7.5		37	32	30	28	26	24	22	21	18	16	12	7
ST 220-04	7.5	10.0		51	44	42	38	35	32	29	28	25	23	18	12
ST 220-05	9.3	12.5		64	57	54	50	46	43	40	38	35	32	25	18
ST 220-06	11.0	15.0		75	67	64	59	54	50	46	44	40	37	29	20
ST 220-08	13.0	17.5		103	92	87	80	74	67	63	59	55	51	41	29
ST 220-09	15.0	20.0		114	101	96	89	82	75	70	66	61	57	46	32
ST 220-11	18.5	25.0		139	124	118	109	100	92	85	81	75	70	56	41
ST 220-14	22.0	30.0		177	156	148	137	126	115	107	101	94	88	72	53
ST 220-16	26.0	35.0		202	179	170	157	144	132	123	116	108	101	83	61
ST 220-19	30.0	40.0		240	213	202	188	171	157	146	138	129	120	99	72
ST 220-23	37.0	50.0		292	262	250	233	213	195	182	171	160	149	123	92

Dimensions and Weights

Pump Type	Motor Type	Dimensions (mm)					Net Weight (kg)
		A	B	C	C*	C**	PUMP
ST 220-02	4"	469	Rp 3" NPT 3"	138	—	—	8.9
ST 220-03		529		138	—	—	9.9
ST 220-04		589		138	—	—	10.9
ST 220-03	6"	543		—	141	144	10.7
ST 220-04		603		—	141	144	11.7
ST 220-05		663		—	141	144	12.6
ST 220-06		723		—	141	144	13.6
ST 220-08		843		—	141	144	15.5
ST 220-09		903		—	141	144	16.5
ST 220-11		1023		—	141	144	18.5
ST 220-14		1203		—	141	144	21.5
ST 220-16		1323		—	141	144	23.6
ST 220-19		1555	—	141	144	27.6	
ST 220-23	1795	—	141	144	31.3		

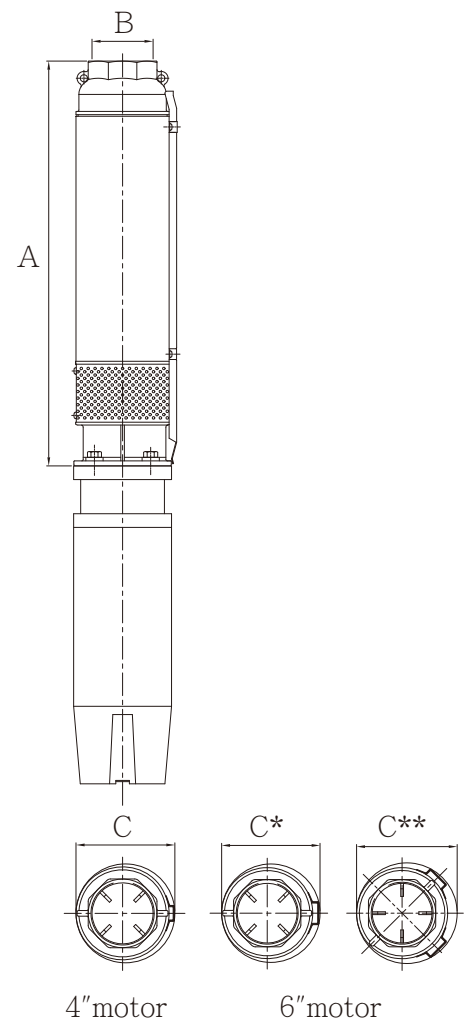



 **STAIRS**

No.6-7-1,Shanzijiao, Lucao Township, Chiayi County 61158, Taiwan
Tel :+886 5 3750488 Fax:+886 5 3755658
www.stairs.com.tw E-mail:stairs@stairs.com.tw

1140924

